

# RADIO-CRAFT

HUGO GERNSBACK, *Editor*



**RADIO**  
..... *Beauty Aid!*  
See Page 134



**SOUND! FIRE! WATER!**



**"AMOS" RILES "ANDY"**



**THEATRE TELEVISION!**

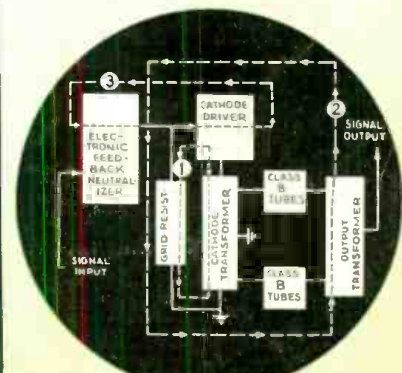

**NEUTRALIZED FEEDBACK!**

**EPT. 25c** RADIO'S GREATEST MAGAZINE  
P. A. CONTEST AWARDS • TELLY IMAGE ON SERVICE 'SCOPE  
MAKE A 5-20 METER ADAPTER • LATEST TREASURE LOCATOR

U.S. AND CANADA



It's NEW—and it's the one and only

# P. A. HANDBOOK

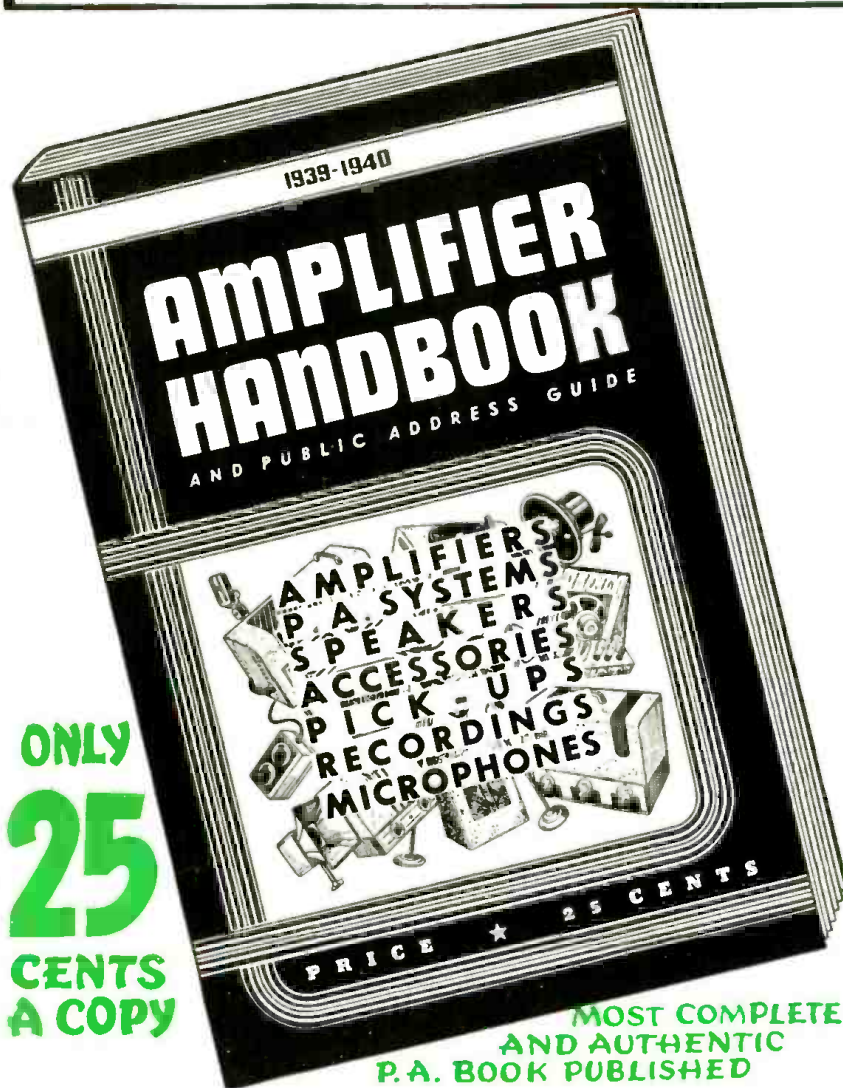

ONLY  
**25**  
CENTS  
A COPY

THAT no book has yet been published which covers amplifiers and sound systems (also kindred systems) in one complete, authentic volume is almost unbelievable. Yet, it is a fact, there is no book in print which covers Public Address from A to Z. To bridge this wide-spread gap, RAD-CRAFT will publish, on August 15th, a volume on Public Address of such magnitude—so complete and authoritative—that every man engaged in radio can have both a theoretical and practical knowledge of the function and operation of sound systems. The editorial pages are so filled with instruction and complete with illustrations that the volume fully justifies its title—**1939-1940 AMPLIFIER HANDBOOK AND PUBLIC ADDRESS GUIDE**. This great HANDBOOK on Public Address should be read and studied by those who consistently build, service and sell sound equipment.

#### A MATCHLESS VOLUME

As complete as you would expect to find any engineering handbook—this is how the radio or P. A. man finds the **AMPLIFIER HANDBOOK AND PUBLIC ADDRESS GUIDE**. With essential technical data compiled from an exceptionally large number of sources, the volume covers nearly two hundred different subjects coordinating every conceivable branch or sub-division of Public Address.

#### THE CONTENTS

To actually show the scope and magnitude of the **AMPLIFIER HANDBOOK AND PUBLIC ADDRESS GUIDE**, an analysis of the contents is found at the right, showing the breakdown of the material featured within each particular section. A thorough reading of the contents shows the completeness of this book.

**RADCRAFT PUBLICATIONS ■ 99 HUDSON STREET ■ NEW YORK, N. Y.**

RADCRAFT PUBLICATIONS, INC. ★ 99 HUDSON STREET ★ NEW YORK, N. Y. RC-939  
Gentlemen: Enclosed find my remittance of 25c for which send me **POSTPAID**, one copy of your **NEW—1939-1940 AMPLIFIER HANDBOOK AND PUBLIC ADDRESS GUIDE**.

Send me ..... others, for friends, also **POSTPAID** @ 25c each.

Name ..... Address .....

City ..... State .....

Remit by check or money order; register letter  
if you send cash or unused U.S. Postage Stamps.

## A Resume of the Contents of the **AMPLIFIER HANDBOOK AND PUBLIC ADDRESS GUIDE**

### PREFACE

#### INTRODUCTION

#### CHAPTER I—FUNDAMENTALS

Vacuum Tube as Amplifier—Ratings—Belts and Decibels—Harmonics—Distortion—Attenuation—Gain—Ohm's Law—Bridge Circuits—Rectification—Microphones—Condensers—Resistors—Impedance—Phase—Resonance—Inductance—Frequency—Magnetics—Shielding.

#### CHAPTER II—VACUUM TUBES

Voltage Amplifiers—Power Amplifiers—Control and Indicator Tubes—Rectifiers—Ballast and Rectulator.

#### CHAPTER III—CIRCUIT ANALYSIS

Inputs—Coupling—Degeneration (Inverse Feedback)—Frequency Compensation—Outputs—Push-Pull—Phase Inversion—Class A, A-R, B, A1, etc.—Hum-Bucking—Automatic Gain Control—Spectrum Control—Time-Delay—Tone Compensation—Voltage Dividers—Swinging Chokes—Beam Power—Push-Push.

#### CHAPTER IV—MICROPHONES

Carbon—Condenser—Electrodynanic—Ribbon (Velocity)—Crystal—Lapel—Uni-directional (cardioid)—Electromagnetic—Transducers.

#### CHAPTER V—AMPLIFIERS AND PREAMPLIFIERS

A.C.—D.C.—A.C.-D.C. (120 V.)—A.C.-D.C. (6 V. D.C. - 120 V. A.C.)—Mobile—Portable—Multi-Channel—Biphonic—Preamplifiers—Monitors.

#### CHAPTER VI—LOUDSPEAKERS

Magnetic—Dynamic—P.M. Dynamic—Crystal—Horn Units.

#### CHAPTER VII—HORNS AND BAFFLES

Flat—Infinite—Octave Resonance—Exponential—Flares—Labyrinths—Pseudodynamic—Biphonic.

#### CHAPTER VIII—AMPLIFIER COMPONENTS

Resistors—Condensers—Transformers—Chokes—Fuses—Sockets—Channels and Housings—Meters—Name Plates and Bezels—Terminals—Jacks and Plugs—Switches—Frequency Filters—Bias Cells—Tone and Volume (Attenuator) Controls—Pads—L, T, H, etc.

#### CHAPTER IX—POWER SUPPLIES

Power Lines—Batteries—Converters and Generators—Rectifier Tubes—Dry Rectifiers—Vibrators and Inverters—Bias Supplies—Field Exciters—Ballasts and Regulators.

#### CHAPTER X—ACCESSORIES

Coin Phonographs—P.A. Tuners.

#### CHAPTER XI—RECORDING AND PLAYBACK

Pickups—33 1/3 and 78 r.p.m. Turntables—Film, Disc and Wire—Recorders—Lateral and Vertical (hill-and-dale) Recording—High Fidelity Recording and Playback—Accessories.

#### CHAPTER XII—MATCHING AND MIXING

Input to Amplifier—Amplifier to Line—Line to Speakers—Pads—Attenuators—Matching Amplifiers—Booster Amplifiers.

#### CHAPTER XIII—ACOUSTICS

Absorption—Reverberation and Echo—Low-Level Distribution—High-Level Distribution.

#### CHAPTER XIV—SELLING SOUND

Ethics—Who are the prospects?—What are reasonable charges?—Sidelines—Accounting—Advertising and Publicity.

#### CHAPTER XV—SCHOOL SOUND SYSTEMS

#### CHAPTER XVI—CALL SYSTEMS

Railroads—Hotels—Restaurants.

#### CHAPTER XVII—INTERCOMMUNICATORS

Wire Type—Wired—Radio Type—Switchless—Multiple-Station.

#### CHAPTER XVIII—TALKIES

Soundheads—Amplifiers—Loudspeakers—Sound-on-Film—Sound-on-Disc—Home-Talkies—Commercial-Talkies.

#### CHAPTER XIX—HEARING AIDS

Tubeless—Tube Type.

#### CHAPTER XX—MISCELLANEOUS APPLICATIONS

#### CHAPTER XXI—FORMULAS AND TABLES

#### CHAPTER XXII—TEST EQUIPMENT

Multi-Meters—C.-R. Oscilloscope—A.F. Oscillators—Output (Level) Indicators—V.T. Voltmeters.

#### CHAPTER XXIII—INSTALLATION PROCEDURE

Placement of Equipment (Microphones, Amplifiers, Loudspeakers)—Use of Woofers and Tweeters—Wiring—Indoors and Outdoors—Portable and Mobile Set-Ups—Permanent Installations.

#### CHAPTER XXIV—SERVICING

**Order Your Copy NOW—**

*Clip Coupon and  
Mail Today!*





# Be a RADIO Technician

Many make **\$30 \$40 \$50** a week

I will train you at home for many Good Spare Time and Full Time Radio Jobs

J. E. SMITH, President, National Radio Institute  
Established 25 Years  
He has directed the training of more men for the Radio Industry than anyone else.



**Set Servicing**  
Fixing Radio sets in spare time pays many \$5, \$10, \$15 a week extra while learning. Full time repair pays as much as \$30, \$40, \$50 a week.

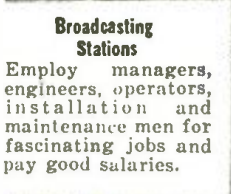

**Broadcasting Stations**  
Employ managers, engineers, operators, installation and maintenance men for fascinating jobs and pay good salaries.



**Loud Speaker Systems**  
Building, installing, servicing, operating public address systems is another growing field for men well trained in Radio.

Radio offers you many opportunities for well-paying spare-time and full time jobs. And you don't have to give up your job, leave home or spend a lot of money to train to get those jobs—to become a Radio Technician.

**Get Ready Now for Jobs Like These**

Radio broadcasting stations employ engineers, operators, station managers and pay well for trained men. Fixing Radio sets, in spare time pays many \$200 to \$500 a year—full time jobs with Radio jobbers, manufacturers and dealers, as much as \$30, \$40, \$50 a week. Many Radio Technicians open full or part time radio sales and repair businesses. Radio manufacturers and jobbers employ testers, inspectors, foremen, engineers, servicemen, in good-pay jobs with opportunities for advancement. Automobile, police, aviation, commercial Radio and loud speaker systems are newer fields offering good opportunities now and for the future. Television promises to open many good jobs soon. Men I trained have good jobs in these branches of Radio. Read how they got their jobs. Mail coupon.

**Why Many Radio Technicians Make \$30, \$40, \$50 a Week**

Radio is young—yet it's one of our large industries. More than 28,000,000 homes have one or more Radios. There are more Radios than telephones. Every year millions of Radios get out of date and are replaced. Millions more need new tubes, repairs. Over \$50,000,000 are spent every year for Radio repairs alone. Over 5,000,000 auto Radios are in use; more are being sold every day, offering more profit-making opportunities for Radio experts. And RADIO IS STILL YOUNG, GROWING, expanding into new fields. The few hundred \$30, \$40, \$50 a week jobs of 20 years ago have grown to thousands. Yes, Radio offers opportunities—now and for the future!

**Many Make \$5, \$10, \$15 a Week Extra in Spare Time While Learning**

The day you enroll I start sending Extra Money Job Sheets; show you how to do Radio repair jobs. Throughout your training I send plans and directions that made good spare time money—\$200 to \$500—for hundreds, while learning. I send you special Radio

equipment to conduct experiments and build circuits. This 50-50 method of training makes learning at home interesting, fascinating, practical.

**I Also Give You This Professional Servicing Instrument**



Here is the instrument every Radio expert needs and wants—an All-Wave, All Purpose Set-Servicing Instrument. It contains everything necessary to measure A.C. and D.C. voltages and current; to test tubes, resistance; adjust and align any set, old or new. It satisfies your needs for professional servicing after you graduate—can help you make extra money fixing sets while training.

**You Are Trained for Television Also**

With N. R. I., you take up Television principles right along with Radio principles—the correct method—since Television receivers combine both sight and sound. You also get more than ten text books devoted entirely to Television.

**Find Out What Radio Offers You**

Act Today. Mail the coupon now for "Rich Rewards in Radio." It points out Radio's spare time and full time opportunities and those coming in Television; tells about my training in Radio and Television; shows you letters from men I trained, telling what they are doing and earning; tells how my Money Back Agreement protects you. Find out what Radio offers YOU! MAIL COUPON in an envelope, or paste on a postcard—NOW!

J. E. SMITH, Pres., National Radio Institute  
Dept. 9JX  
Washington, D. C.

**HERE'S PROOF THAT MY TRAINING PAYS**



**\$50 Monthly in Spare Time**

"I work on Radio part time, still holding my regular job. Since enrolling seven years ago, I have averaged around \$50 every month!"  
JOHN B. MORISSETTE, 809 Valley St., Manchester, N. H.

**Makes \$50 to \$60 a Week**

"I am making between \$50 and \$60 a week after all expenses are paid, and I am getting all the Radio work I can take care of, thanks to N. R. I." H. W. SPANGLER, 126 1/2 S. Gay St., Knoxville, Tenn.



**Operates Public Address System**

"I have a position with the Los Angeles Civil Service, operating the Public Address System in the City Hall Council. My salary is \$170 a month." R. H. BOOD, R. 136, City Hall, Los Angeles, Calif.



**Sample Lesson Free**

I want to prove that my Training gives practical, money-making information, is easy to understand—is what you need to master Radio. My sample lesson text, "Radio Receiver Troubles—Their Cause and Remedy" covers a long list of Radio receiver troubles in A.C., D.C., battery, universal, auto, T. R. F., superheterodyne, all-wave, and other types of sets. And a cross reference system gives you the probable cause and a quick way to locate and remedy these set troubles. A special section is devoted to receiver checkup, alignment, balancing, neutralizing and testing. Get this lesson FREE. No obligation. Just mail coupon.



**THIS FREE BOOK HAS HELPED HUNDREDS OF MEN MAKE MORE MONEY**



**This Coupon is Good for One FREE Copy of My Book**

J. E. SMITH, President, Dept. 9JX  
National Radio Institute, Washington, D. C.

Dear Mr. Smith: Without obligation, send me free the Sample Lesson and your 64-page Book, "Rich Rewards in Radio," telling about spare time and full time Radio opportunities, and how I can train for them at home in spare time. (Please write plainly.)

NAME ..... AGE .....

ADDRESS .....

CITY ..... STATE ..... 14-X1

Please Say That You Saw It in RADIO-CRAFT

# RADIO-CRAFT

HUGO GERNSBACK, *Editor-in-Chief*

N. H. LESSEM  
*Associate Editor*

THOS. D. PENTZ  
*Art Director*

ROBERT EICHBERG  
*Trade Digest Editor*

R. D. WASHBURNE, *Managing Editor*

## Contents SEPTEMBER, 1939 Issue

VOLUME XI -- NUMBER 3

Editorial: "Dear Radio Industry":—An Open Letter to the Radio Industry .....	Hugo Gernsback	133
The Radio Month in Review.....		134
Making a 4-Tube Battery "Permeability Portable".....	N. H. Lessem	136
Television Experiments with a Servicing 'Scope.....	Ricardo Muniz	138
Awards—" \$4,000 Public Address Contest" (Part I).....		140
9 New Tubes.....	R. D. Washburne	141
Ham "Amos" and Pilot "Andy".....		142
3-Dimension 2-Kw. P.A. at New York Fair.....		143
Marine Radio Telephone—Latest Field for Servicemen .....	S. Gordon Taylor	144
How to Make a Modern Radio Treasure Locator.....	Allan Stuart	146
Servicing Television Receiver Faults—Part IV.....	S. West	148
Servicing "Coin-Operated" Phonographs—No. 4.....	Sanford Miller	150
New Circuits in Modern Radio Receivers—No. 24.....	F. L. Sprayberry	151
Mailbag .....		152
Servicing Questions & Answers.....		153
Operating Notes .....		153
Successful Servicing .....		153
Universal 32-W. Neutralized-Feedback P.A. Amplifier.....	A. C. Shaney	154
Build this 5- to 20-Meter Telly-Sound Adapter .....	Glenn H. Browning & F. J. Gaffney	156
Getting Into Television Servicing.....	Charles Sicuranza	158
<b>RADIO SERVICE DATA SHEETS:</b>		
No. 260—Stewart-Warner 6-Tube Model A-6 "Air-Pal" (Chassis 07-31) .....		160
No. 261—Automatic Radio Mfg. Co. "3-in-1" Models P-57 and P-58 Portables .....		161
The Latest Radio Equipment.....		162
Radio Trade Digest.....		163
Book Reviews .....		131

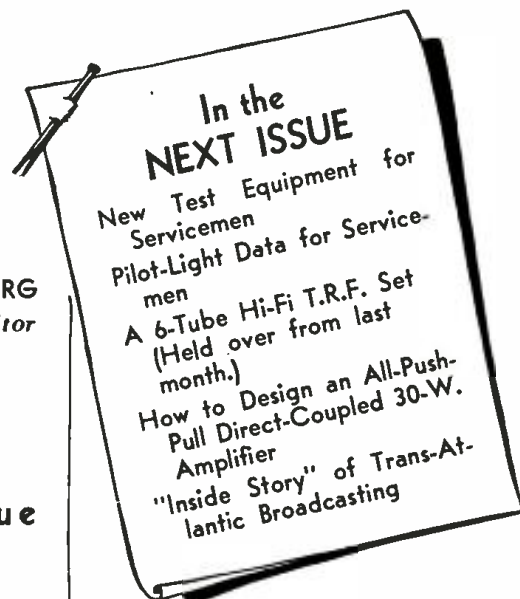

★

"Television Experiments with a Servicing 'Scope," in this issue of *Radio-Craft*, presents what we believe is an exceptionally easy and low-cost means for the Servicemen and others, who own the approximately 5,000 service oscilloscopes now on the market, to experiment in the rapidly-growing field of Television. For those who live outside the range of television stations *Radio-Craft* hopes to soon be able to present an article on an easily-built, experimental telly transmitter.

★

Published by Radcraft Publications, Inc. Publication office: 29 Worthington Street, Springfield, Mass. Editorial and Advertising Offices: 99 Hudson Street, New York City. Chicago Advertising Office: RADIO-CRAFT, 520 North Michigan Avenue, Chicago, Ill.

RADIO-CRAFT is published monthly, on the first of the month preceding that of date; subscription price is \$2.50 per year in U. S. and Canada. (In foreign countries, \$3.00 a year to cover additional postage.) Entered at the post office at Springfield as second-class matter under the act of March 3, 1879.

Foreign Agents:

London—Gorrings's American News Agency, 9A Green St., Leicester Square, W. C. 2, England.  
Paris—Messageries Dawson, 4 Rue Faubourg Poissonniere, France.  
Melbourne—McGill's Agency, 179 Elizabeth St., Australia.  
Dunedin—James Johnston, Ltd., New Zealand.

★

Text and illustrations of this magazine are copyright and must not be reproduced without permission of the copyright owners.

★

Copyright 1939 Radcraft Publications, Inc.



## BOOK REVIEWS

**APPLIED ACOUSTICS**, 2nd Edition, by Harry F. Olson and Frank Massa (1939). Published by P. Blakiston's Son & Co., Inc. Size 6 x 8 1/4 ins., cloth cover, 494 pages, profusely illustrated. Price, \$5.50.

Engineering advances in electro-acoustics during the 5 years since the 1st Edition of the book have warranted the issuance of this new, revised 2nd Edition. Improved loudspeakers and microphones are among the new developments the authors describe.

Chapter headings follow: Fundamental Equations and Definitions; Dynamical Systems—Electrical, Mechanical and Acoustical Elements and Systems of Elements; Fundamental Acoustical Measurements; Electrical Apparatus for the Acoustical Laboratory; Microphones (and their calibration); Telephone Receivers (and tests); Loudspeakers (and tests); Loudspeakers; Measurements of Noise; Architectural and Physiological Acoustics; Miscellaneous Acoustic Applications.

**PRODUCTION AND DIRECTION OF RADIO PROGRAMS**, by John S. Carlile (1939). Published by Prentice-Hall, Inc. Size 6 1/2 x 9 1/2, cloth cover, 55 illustrations, 397 pgs. Price, \$3.75.

In this book the production manager of one of the world's largest broadcasting systems shows you how to achieve the motion and color, the split-second timing and the ear-appeal that distinguish radio's top-notch dramatic, musical and educational programs.

The radio technician will find especially useful the diagrams of ideal studio layouts and the descriptions of sound-effects equipment. The book is divided into parts as follows: The Program and Those Who Produce It; The Production of Musical Programs; Precision and Routine; Speech; Appendix.

This is the first book to give the real inside story on broadcasting.

**TELEVISION CYCLOPEDIA**, by M. N. Beitman (1939). Published by Supreme Publications. Size 5 1/2 x 8 1/2 ins., profusely illustrated, paper cover, 64 pgs. Price, 50c.

Well illustrated, this book is an excellent cross-section of modern television. It is recommended to anyone who contemplates getting into television inasmuch as it affords immediate and convenient reference to television's technical terms and their meaning.

**RADIO-CRAFT LIBRARY REDBOOK**. Published by Radcraft Publications, Inc. Size 6 x 9 ins., paper covers, 64 pgs. Price, 50c.

No. 23—**PRACTICAL PUBLIC ADDRESS**, by B. Baker Bryant (1939); 54 illustrations.

A considerable amount of the information in this valuable book on modern methods of servicing and installing public-address equipment has been obtained by the author through practical experience in installing, designing and servicing sound and public-address equipment. The chapters in "Practical Public Address" are as follows: I—Introduction; II—Microphones. Characteristics and Principles of Operation; III—Public Address Amplifiers; IV—Installation and Construction; V—Acoustics; VI—Servicing and Formulas; VII—Useful Charts and Tables.

Well illustrated, "Practical Public Address" fills a long-felt want for a book which describes in simple language the elements of public address and which coordinates this information in its practical application to the many P.A. amplifier circuits which are shown in the book by diagram.

**AIR CONDITIONING—Principles and Practice**, by Burgess H. Jennings (1939). Published by International Textbook Company. Size, 6 x 9 ins., flexible binding, 150 illustrations, 467 pgs. Price, \$4.00.

Radio Servicemen connected with organizations in which they are called upon to service air-conditioning equipment will find "Air Conditioning" an invaluable reference. Every imaginable phase of air conditioning is treated in textbook fashion, with actual examples and their solutions.

**TRATADO GENERAL DE RADIO ELECTRICIDAD (A General Study of Radio, Vol. I)**, by Alberto A. Ferriol (1938). Published by Editorial Radio-Lectura, Buenos Aires, S. A. Size 6 x 7 1/2,



**MAKE TWICE AS MUCH AS USUAL ON SERVICE CALLS!**

Read how you can make your service calls pay double with an

**RCA Victor RECORDER**



**TAKE ADVANTAGE** of human nature — and make more money! Get yourself one of these new portable RCA Victor Recorders—and when you make your next service call bring it along with you. Everybody would like to own a personal record. And you'll be able to accommodate. The RCA Victor Recorder will soon pay for itself—and the rest is gravy for you. Get full details about this remarkable, compact instrument that makes personal records. Ask your RCA Victor distributor—or mail the coupon.

**FOR FINER RADIO PERFORMANCE**  
—RCA VICTOR RADIO TUBES

Listen to the Magic Key, every Monday, 8:30 to 9:30 P.M., E.D.S.T., on NBC Blue Network.

PUT IT ON  A RECORD

RCA Victor

RECORDERS

Commercial Sound Section • RCA Mfg. Co., Inc.  
Camden, N. J. • A Service of Radio Corp. of America

Portable RCA Victor Recorder M1-12701 comes in attractive gray carrying case with handle. Turntable speed 78 r.p.m. Will handle discs up to 12". All necessary elements for recording and reproducing, including RCA Aerodynamic Microphone. Employs outside-in recording method. \$179.00\*.

### AMATEURS

This new RCA Victor Portable Recorder will double your DX enjoyment. With it you can put the important and interesting things you broadcast or receive on records.

\*Price f.o.b. Camden, N.J., subject to change without notice.

Commercial Sound Section, Dept. RC-9  
RCA Mfg. Co., Inc., Camden, N. J.

Gentlemen: Please send me without obligation full details on RCA Victor Recorders.

Name \_\_\_\_\_

Street \_\_\_\_\_

City \_\_\_\_\_ State \_\_\_\_\_

paper cover, 379 pgs., 161 illustrations. Price, \$4.00.

How is your Spanish? If you think you can make your way through an elementary technical book on radio theory written completely in Spanish and including elementary mathematics, we can recommend this publication to such beginners in radio. An especially interesting and detailed analysis of the derivation of alternating current and its relation to phase is included.

**BBC HANDBOOK 1938**. Published by The British Broadcasting Corp. Size 5 x 7 1/2. 128 pgs., illustrated. Price 1s. 6d. (approx. 40c).

As with preceding issues of this important annual record of work by the British Broadcasting Corp., the treatment is essentially chronological and historical. Its technical content is treated in general fashion. This is an excellent reference to the work of the B.B.C. last year.

**AERONAUTIC RADIO**, by Myron F. Eddy (1939). Published by The Ronald Press Company.

Size 6 x 8 1/4 ins., cloth cover, 502 pgs., 178 illustrations. Price, \$4.50.

Aeronautic Radio is a practical book for all persons interested in any phase of the subject—students, mechanics, operators, pilots, and air transport operating executives. Throughout its preparation, Mr. Eddy has been guided by two considerations: First, the requirements of the Federal Communications Commission as to the aviation radio operators' licenses and the regulations of the Civil Aeronautics Authority as to radio in aeronautics. Second, the actual approved usage of existing equipment for both communication and for special purposes such as course guidance and instrument landing.

The first 11 chapters of this manual, if carefully studied, should prepare the reader to pass the theoretical part of the examination for an aviation radio operator's license; 198 test questions appearing in conjunction with this portion of the text, are an especially helpful feature. The next 5 chapters explain special applications of radio to aeronautics that are of growing importance.

Please Say That You Saw It in RADIO-CRAFT

# For Better Servicing - - For Bigger Profits - - Use Gernsback Manuals and Books!

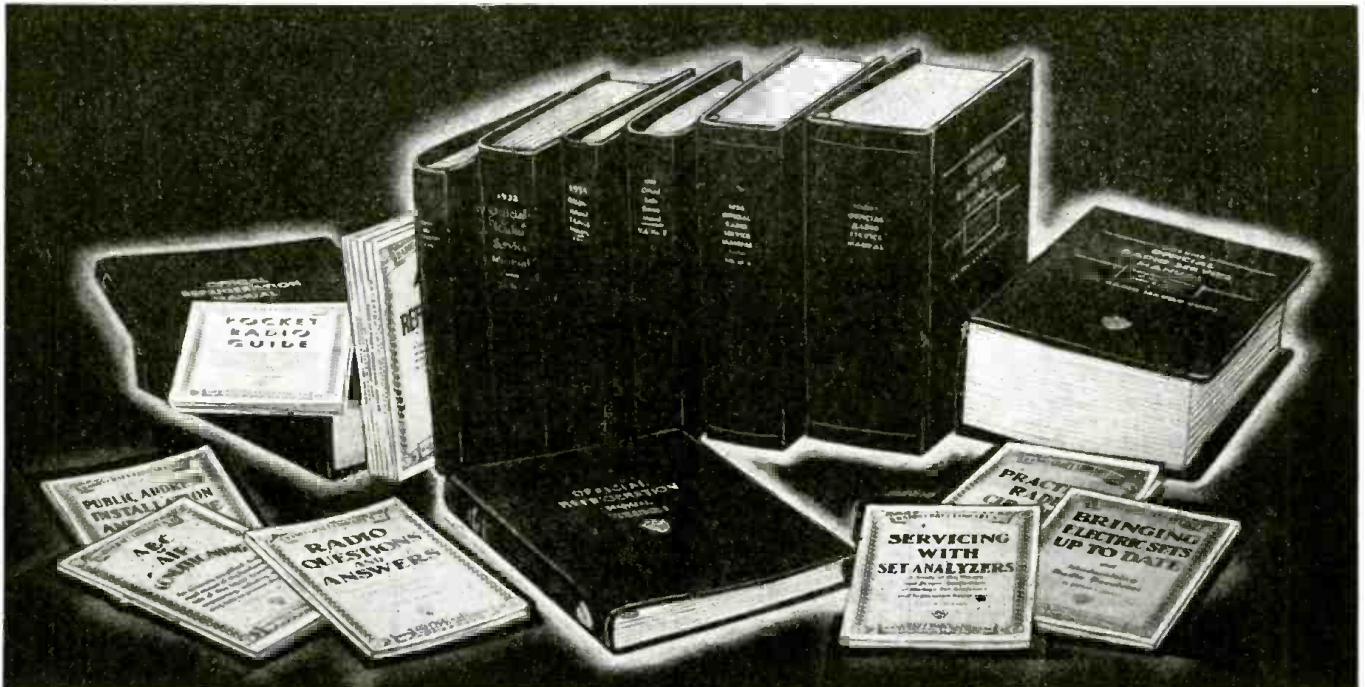

**S**INCE 1931 Servicemen have been buying more GERNSBACK OFFICIAL RADIO SERVICE MANUALS year after year. The authentic material, easily accessible diagrams and complete service data make them invaluable to dealers and radio Servicemen. Without a Gernsback Service Manual at the repair job, there's time and profit lost. Your service kit or laboratory is incomplete without all the GERNSBACK OFFICIAL RADIO SERVICE MANUALS. There are GERNSBACK MANUALS for servicing auto-radios, also refrigeration and air conditioning equipment.

- VOLUME 7 OFFICIAL RADIO SERVICE MANUAL**  
Over 1,800 Pages • Over 3,000 Illustrations • Stiff, Leatherette, Looseleaf Covers • Size 9 x 12 Inches • Net Weight 10 1/2 lbs. **\$10.00**
- 1936 OFFICIAL RADIO SERVICE MANUAL**  
Over 1,200 Pages • Over 2,500 Illustrations • Stiff, Leatherette, Looseleaf Covers • Size 9 x 12 Inches • Net Weight 8 lbs. **\$7.00**
- 1935 OFFICIAL RADIO SERVICE MANUAL**  
Over 1,000 Pages • Over 3,000 Illustrations • Flexible, Leatherette, Looseleaf Covers • Size 9 x 12 Inches • Net Weight 3 3/4 lbs. **\$7.00**
- 1935 OFFICIAL AUTO-RADIO SERVICE MANUAL**  
Over 240 Pages • Over 500 Illustrations • Flexible, Leatherette, Looseleaf Covers • Size 9 x 12 Inches • Net Weight 1 3/4 lbs. **\$2.50**
- 1934 OFFICIAL RADIO SERVICE MANUAL**  
Over 400 Pages • Over 2,000 Illustrations • Flexible, Leatherette, Looseleaf Covers • Size 9 x 12 Inches • Net Weight 2 1/2 lbs. **\$3.50**
- 1932 OFFICIAL RADIO SERVICE MANUAL**  
Over 1,000 Pages • Over 2,000 Illustrations • Flexible, Leatherette, Looseleaf Covers • Size 9 x 12 Inches • Net Weight 4 1/2 lbs. **\$5.00**
- OFFICIAL REFRIGERATION SERVICE MANUAL (Volume II)**  
Over 352 Pages • Over 300 Illustrations • Flexible, Leatherette, Looseleaf Covers • Size 9 x 12 Inches • Net Weight 1 1/2 lbs. **\$5.00**
- OFFICIAL AIR CONDITIONING SERVICE MANUAL**  
Over 352 Pages • Over 600 Illustrations • Flexible, Leatherette, Looseleaf Covers • Size 9 x 12 Inches • Net Weight 2 1/2 lbs. **\$5.00**

To order these famous Manuals, see or write to your jobber or favorite mail order house. If more convenient, mail coupon directly to publishers.

**RADCRAFT PUBLICATIONS, Inc.**  
89 HUDSON STREET NEW YORK, N. Y.

Get into the swing of reading instructive, authoritative books on technical subjects—radio, air conditioning and refrigeration. It's the easiest, quickest and most inexpensive way to improve your knowledge on these topics. In this series, popularly known as the RADIO-CRAFT LIBRARY SERIES, are all the titles necessary to your personal advancement. Only by careful study of these enlightening books, can you gain adequate experience in fields of radio, air conditioning and refrigeration. Each book is uniform. The volumes measure 6 x 9 inches—contain 64 pages, and have stiff, flexible covers. PRICE 50c PER BOOK. All books are sent to you postpaid.

### Here Are The Titles:

- |   |   |
|---|---|
| Book No. 2<br>MODERN VACUUM TUBES               | Book No. 18<br>POINT-TO-POINT RESISTANCE ANALYSIS   |
| Book No. 6<br>BRINGING ELECTRIC SETS UP-TO-DATE | Book No. 19<br>PRACTICAL RADIO KINKS AND SHORT CUTS |
| Book No. 13<br>ABC OF AIR CONDITIONING          | Book No. 20<br>THE CATHODE-RAY OSCILLOSCOPE         |
| Book No. 14<br>POCKET RADIO GUIDE               | Book No. 21<br>BREAKING INTO RADIO SERVICING        |
| Book No. 15<br>ABC OF REFRIGERATION             | Book No. 22<br>NEW RADIO QUESTIONS AND ANSWERS      |
| Book No. 16<br>PRACTICAL RADIO CIRCUITS         | Book No. 23<br>PRACTICAL PUBLIC ADDRESS             |
| Book No. 17<br>SERVICING WITH SET ANALYZERS     |   |

EACH BOOK IN THIS SERIES—50c

**RADCRAFT PUBLICATIONS, Inc., 99 HUDSON ST., NEW YORK, N. Y.**  
Gentlemen: Enclosed find my remittance of \$..... for which send me, POSTPAID, the Manuals or Books Indicated below by a cross (x) in the Panel.

( ) Volume 7 @ \$10.00      ( ) 1936 Manual @ \$7.00      ( ) 1935 Manual @ \$7.00  
 ( ) 1935 Auto-Manual @ \$2.50      ( ) 1934 Manual @ \$3.50      ( ) 1932 Manual @ \$5.00  
 ( ) Refrigeration Manual (Vol. 2) @ \$5.00      ( ) Air Conditioning Manual @ \$5.00

**RADIO-CRAFT LIBRARY SERIES @ 50c EACH**  
 Circle book numbers wanted: 2 6 13 14 15 16 17 18 19 20 21 22 23

Name ..... Address .....

City ..... State .....

(Send remittance in form of check or money order; register your letter if you send cash or unused U. S. Postage Stamps.) RC-939

Please Say That You Saw It in RADIO-CRAFT



# RADIO-CRAFT

“RADIO'S GREATEST MAGAZINE”

## “DEAR RADIO INDUSTRY”: An Open Letter to the Radio Industry

By HUGO GERNSBACK, *Editor*.

**A**S one who has watched the ups and downs of the radio industry since 1904, may I be permitted to voice a few thoughts about the present destructive policy manifested in certain quarters against television?

Not so long ago, in the March issue of *Radio-Craft*, I had occasion to point out to the industry that its present tactics will hurt business, not only of radio but television as well. I quote two paragraphs from that editorial:

“At any rate, the best policy for the radio trade to pursue at the present time is not to confuse the public by squabbling within the trade. Let the industry read its own radio history, and take heed of the lesson that it should have learned, and that is:

*“Those who have opposed radio progress most strenuously in the past, were the first ones to be wiped out by the march of radio progress.”*

During the recent radio show in Chicago, the Radio Manufacturers Association took great pains to put a new damper on television, telling the public that television was not ready and would not be for a long time to come.

The statement was made, most likely, on behalf of radio set manufacturers who quite selfishly and needlessly are worried that the public will not buy radio sets until television is more perfected.

Destructive publicity of this type always rebounds as a boomerang on those who launch it. History always has a way of repeating itself, particularly radio history which has shown in the past that, of all those least qualified to prognosticate the radio future, members of the radio industry are the most outstanding.

If you don't believe this, see what happened during the radio boom in the 20's. Here we had the ridiculous situation where those in the radio industry who as pioneers should have shared in the radio prosperity, were completely wiped out by a horde of ex-pants pressers, real estate dealers, speculators, promoters and others who knew nothing whatsoever about radio, but who could look further ahead than the members of the radio industry of that day. It is a safe bet that exactly the same thing will happen in television. The radio manufacturers, instead of using every available means to ballyhoo and propagandize television, now go to great pains to tell, not only the public, but each other, that there is nothing to television, that it isn't ready, and that it will take many years before we will have television at all.

Now let us get down to brass tacks and look at the facts. Up to the present time, no one in television has had the courage to put up real money, with the exception of the Radio Corporation of America, to encourage the new art, only to be damned immediately for what they have accomplished. The radio set industry in some instances has responded by making a number of sets but, instead of erecting stations, so that the public in various parts of the country could have a look-in at television, they now sit back and melancholi-

cally complain that the “damned sets aren't selling.” With the exception of the Metropolitan New York district that is probably true. For what good reason should television sets sell anywhere else, where there is no television broadcasting in existence?

While we are at it, may we ask the Columbia Broadcasting System why they are not on the air with television at this time? A number of announcements have been made by Columbia that they would go on the air shortly after May. As we go to press, it is July, Columbia still has no television program on the air, and it isn't possible to find out when they will start broadcasting. What is holding television back, so far as the Columbia Broadcasting System is concerned?

As far as we know, the installation of their transmitters is complete or nearly so, at least in the New York area. But again this, we believe, shows a lack of foresight because the Metropolitan New York district is already served by the National Broadcasting Company and it might, therefore, be much better for Columbia to start broadcasting, if they ever do, in another center; let us say, Chicago.

As for the radio set manufacturers themselves, they do not practice what they preach. Witness the spectacle that several radio set manufacturers are now busily engaged to bring out their 1940 radio sets “equipped for television sound.”

What is the reason for this? Apparently, the set manufacturers wish to play safe and would like to straddle television with their sets if they can. In other words they believe that, if you can tune in television sound, and if in a few months some one comes along with a gadget whereby you can pick up television sight (video) with another cheaper unit, not now available, then the public might buy such radio sets. This, to our way of thinking, is all wrong and a pure makeshift that will only confuse the public more. It is like selling an automobile equipped with half a boat on the assumption that, in case you wish to run your car on a lake, somehow you can get the other half of the boat to do the trick later on.

To us it seems that the radio industry, instead of squabbling, instead of having recourse to makeshifts, ought to get themselves together and help to have television transmitters built in various parts of the country; then the television controversy would be settled in short order. What we need today is to have existing radio stations equipped for television broadcasting, before some outsiders jump in and snatch it away from those that are now in the radio broadcasting business.

Even now television isn't so bad, as best proven by the fact that a number of manufacturers—not primarily set manufacturers—are putting out radio television kits, and these seem to be moving at an increased rate.

There is an excellent market for television today, if only the radio industry will believe it and pull together, rather than broadcast doubts and gloom as is their practice now.

# THE RADIO MONTH

## TELEVISION

**R**EPORT in *Radio Daily* last month is that Allen B. duMont is burning the midnight oil developing a super-high-fidelity telly system having 882 lines!

What well-known American radio manufacturer is planning to bring out a theatre-size telly projector capable of filling a screen 200 ft. distant?

Reports last month were that RCA may provide two types of telly entertainment, one for home consumption and the other for theatre reception, when the latter becomes more feasible. It is believed that theatre telly will differ from the home version in that only non-sponsored entertainment will be sent for the theatres.

A short released last month by Metro-Goldwyn-Mayer, and entitled "SOS Tidal Wave," starring Spencer Tracy and Virginia Bruce, employs television for its main theme. A television commentator, to prevent a crooked candidate winning an election, fakes a broadcast.

Television Productions, Inc., Los Angeles, Calif., last month was granted a construction permit for a telly transmitter for the 66 to 72 megacycle band. Power, 1 kw., both visual and aural.

The Journal Co., Milwaukee, Wis., was OK'd by the F.C.C. last month to build a 50 to 56 mc. telly station for *The Milwaukee Journal*. Power, 1 kw.



7 METERS TO BEAUTY

A beauty shop on Hollywood Blvd. is employing the grotesque mask shown above (and on the cover of this issue of *Radio-Craft*), as an applicator of ultra-shortwaves.

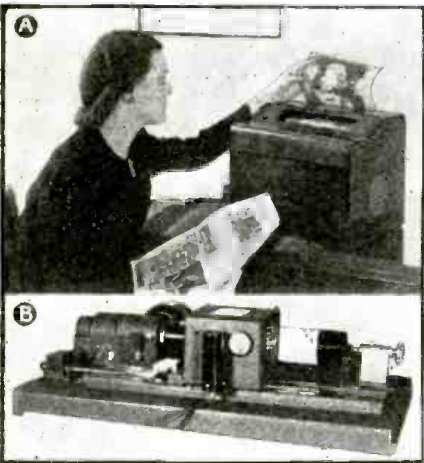

FASTER FACSY

A—Oscillation of the recording pen is eliminated in this new Finch high-speed facsimile recorder. The 5-column tabloid-size paper-tape is acted upon dry-electrochemically, by means of 3 equally-spaced pens on a chain circling continuously in one direction. B—New Finch high-speed facsy transmitters send 8 full tabloid pages per hour.

The May Dept. Stores Co., Los Angeles, Calif., was another West-coaster to get blessings from the F.C.C., last month. Construction permit is for a 1 kw. telly transmitter on 66 to 72 mc.

Kolorama Laboratories, Inc., Irvington, N. J., last month was given the go-ahead sign by the F.C.C. for a composite telly station on the 2,000 to 2,100 kc. band, to operate midnight to 6 A.M., with 500 watts! Station is located at Carlstadt, N. J.

## BROADCASTING

**N.** B.C. ENGINEERS outwitted flames raging in Southern California mountains by sending flashlight messages in Morse code for 2 miles to enable broadcasts of the fire from the scene to go on the air as scheduled, last month.

Fire hazard created by fast-changing winds made it necessary to keep short-wave receivers at a safe distance from the fire lines, from which Announcer Clinton (Buddy) Twiss was describing through a tiny "beer mug" transmitter the worst conflagration in the history of Los Angeles County.

When no other means of communication between Twiss and his receiver, which carried the program to the networks, was available, Engineers Miv Adams and Bob Brooke exchanged messages from one mountain top to another 2 miles away by blinking out the Morse code with flashlights.

The Swiss National Exhibition at Zurich went to town last month in including radio. In addition to setting up a complete radio studio, the Exhibition now has its own 100-watt broadcaster.

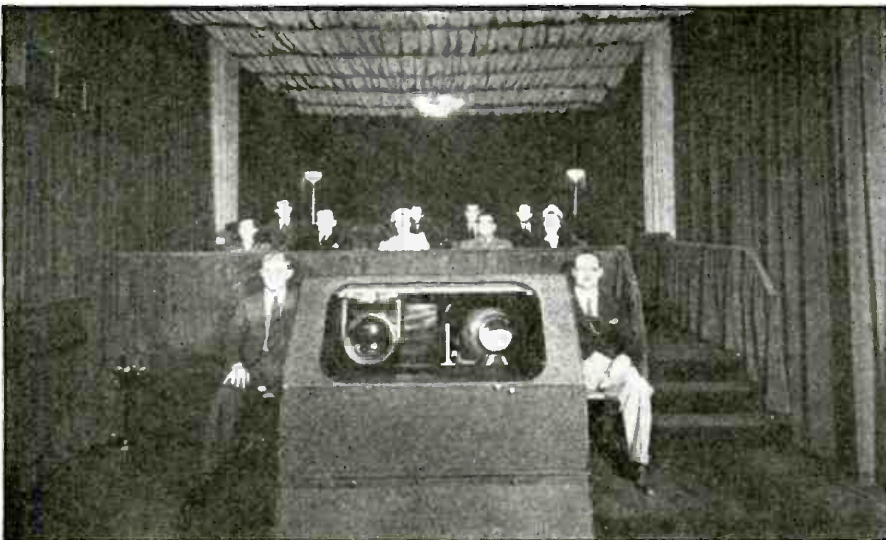

THEATRE-SIZE TELLY ON BROADWAY!

N.B.C./RCA's telecast "Pirates of Penzance" as viewed on a 9 x 12 FOOT screen at Gaumont-British telly theatre on Broadway last month, upset the aplomb of your "R.M. in R." editor, who had not realized John Bull's progress in 405-line television: it took about a month to revamp the 36-tube super-receiver shown here for Uncle Sam's 441-line telly reception. Only auditorium size limitations prevented jacking the high-intensity cathode-ray tube's voltage up another 25% to its normal rating of about 50,000 volts and 1/2-milliamperes for an optimum image size of 15 x 20 ft. A—Lens system (also shown on cover of *Radio-Craft*), in front of 12-in. operating tube at left and slung from overhead carriage, may be instantly slid in front of twin emergency "Cathovisor" (projector tube) at right. B—Pith helmets protected N.B.C.'s telly cameramen from studio lights during the "Pirates" pick-up.

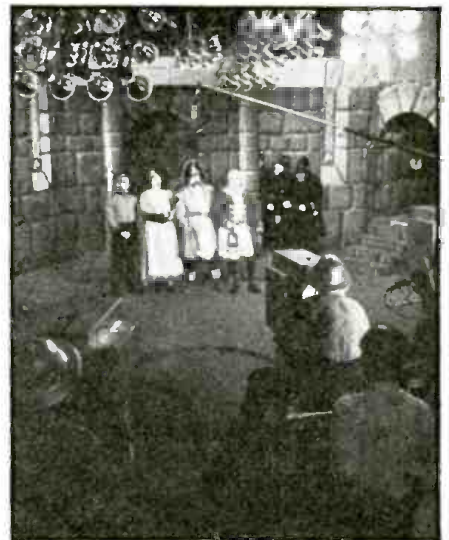



# IN REVIEW

## BREVITEMS

**"S**TOKOWSKY Has 'All-Electric Band,'" read the newspaper headline of a U.P. report last month. It is believed that the great Leopold plans to have a 19-piece orchestra; with it he will tour Europe. His orchestra thus will be about double the size of Adrian Craft's all-electronic orchestra illustrated and described in July *Radio-Craft*.

A  $\frac{3}{4}$ -volt-filament midget tube will shortly make its appearance on the market! Watch *Radio-Craft* for further details. Two of these tubes connected in series may be operated from a single 1.5-volt drycell with no more current consumption than for a single tube of 1.5-volt rating.

September 22 will be De Forest Day at the New York World's Fair 1939, *Radio-Craft* has been advised.

Two radio-controlled, unmanned automobiles were sent into a head-on smash-up at full speed, last month, to test automobile bodies at the Morris Works (England), reported *Practical and Amateur Wireless* (London).

At last England has put to practical use as a gunnery target the radio-controlled airplane illustrated many months ago in *Radio-Craft*. This gem of radio-dynamic wizardry, the 'plane *Queen Bee*, will make movie star Reginald Denny—who is said to have perfected a radio-controlled 'plane for Uncle Sam—watch his laurels in this new radio field. The *Queen Bee* in acting as a target for gunners on H.M.S. *Ark Royal* last month, as reported in *The Times of India*, at times flew as high as 14,000 ft.



RECORDED HISTORY

The Canadian Broadcasting Corp. in collaboration with the Northern Electric Company made discs, on a multi-turntable recorder, of all the King of England's speeches during his Canadian visit last month; many of these discs were used for rebroadcasting. His Majesty is shown (inset) in front of 2 gold mikes.

A lie detector was used for probing the case of alleged tampering with a colt at Belmont Park, last month, for the first time in racing history. Three grooms were double-checked by the device (which has been illustrated in a past issue of *Radio-Craft*) at Fordham University, N.Y.C.

A special "cue" has been devised so that in any verbal emergency Dr. Funk, who knows most of the things stored up in his family's famous dictionaries, may be summoned over the regular WOR 710 kilocycle channel. The "cue" consists of some slight irregularity in program procedure. Upon hearing this—which of course is used only when Dr. Funk should be unavailable by ordinary means—the word-doctor will immediately call the station.

It's a big secret, this "cue" business, and only a limited group compose the inner circle who know what the ethereal sesame might be.

(Continued on page 185)

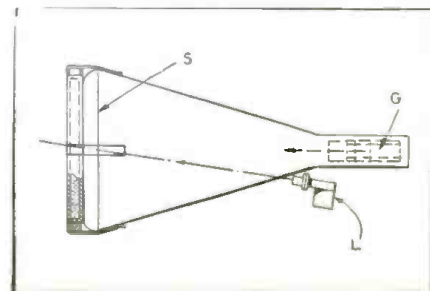

"IRON"-SCREEN PROJECTION TUBE

In "Recent Inventions" *The Wireless World* (London, Eng.), last month, described the illustration shown above. Iron particles act as a light-shutter.

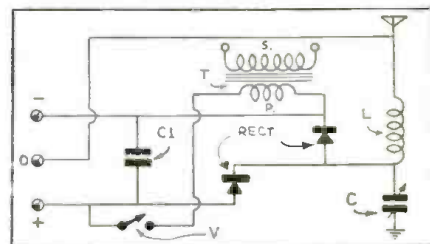

PROGRAMS DETONATE GUNPOWDER!

The circuit shown above, we learned last month from *L'Antenna* (Paris, France) via *Le Journal des "8"*, is a means of putting radio programs to work.



1939 PALEY AWARD TO BURGESS

Wilson E. Burgess, WIBDS of Westerly, R. I., last month was tendered the William S. Paley Amateur Award for heroic performance during the hurricane which devastated large sections of New England last year.



N.B.C./RCA TELEVISION CONTROL ROOM

The N.B.C./RCA Studio Control Room, at Radio City (N.Y.), overlooks the main studio. Of the 3 monitor screens pictured here, the left one shows the image on the air; center one carries preview; right one is for checking defects.

# MAKING A 4-TUBE BATTERY

If you want to have the time of your life, build this lightweight, compact portable superhet.—you go to a baseball or football game which is being broadcast. And as a vacation portable it's

N. H.

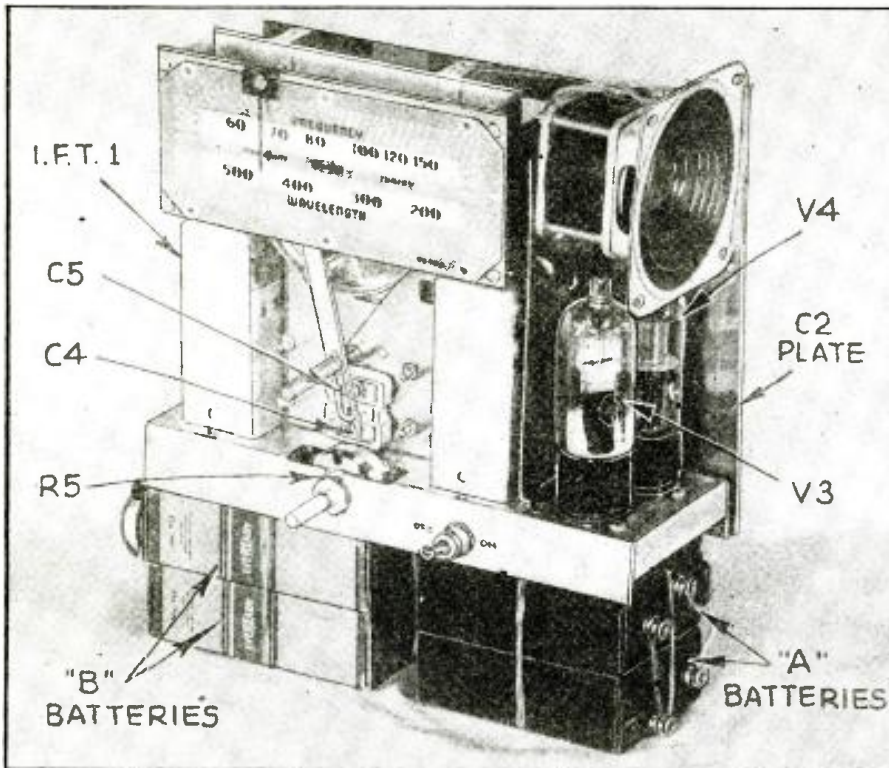

Fig. A. The "permeability portable" is about 1/2 the size of the average commercial portable and less than 1/2 its weight. All components are compactly arranged, but not overcrowded, on the chassis with the P.M. dynamic speaker taking advantage of the space over 2 of the tubes. Build your own carrying case around it or slip it into any convenient-sized case or box you may have on hand. The small size "A" and "B" batteries used will last for a considerable time with average use.

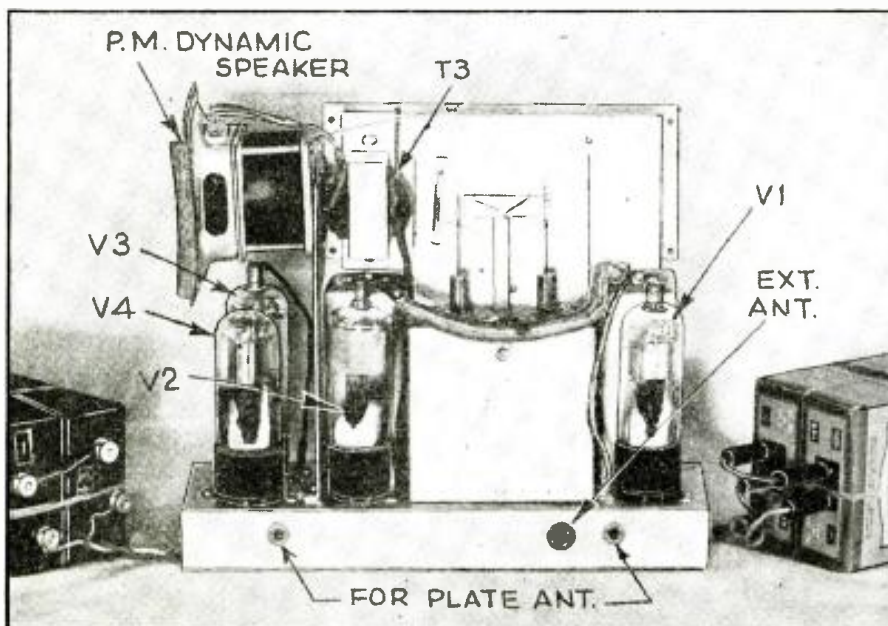

Fig. B. Rear view of the portable showing the locations of the tubes and other components with respect to the permeability tuner. The antenna plate plugs into the 2 extreme jacks and may be used for local reception. When in the country, away from stations, use a 20-ft. length of wire plugged into the remaining jack.

**B**ATTERY portables are quite the vogue today. In fact, they seem to be the only item in the radio industry which is selling—thanks to the new series of low-drain 1.4-V. battery-type tubes. Most of these portables are 4- and 5-tube superhets., using automatic volume control, tone control, pushbutton tuning, permanent-magnet dynamic speakers, and all the other accoutrements of modern radio. They are really fine jobs and the radio manufacturers are to be congratulated on their fine engineering—but not on their physical design. And here is where we come in.

The battery Permeability Portable described in this article not only is half the cubic dimension of the average commercial job but, more important, less than half its weight (only 6½ lbs.). It is really a "package" of radio since it can be thrown into one corner of the vacation luggage and taken and operated anywhere; or, it may be carried by its own handle.

Incidentally, talking about its handle, the carrying case for this portable may be any convenient-size box or case which you may have on hand. The author did not take the time to have one built inasmuch as the various constructors will probably exercise their own choice or utilize existing cases—they always do.

## CAPACITY ANTENNA

Construction of this set has been greatly simplified, too, in an entirely new direction. No longer is it necessary to laboriously wind a loop antenna, in order to secure the advantages of a built-in aerial, and then spend perhaps hours trying to secure tracking of the tuning system over the entire tuning range.

Instead, a *capacity antenna* (\*) is used. Tested in *Radio-Craft* offices, inside a steel building, this novel, built-in antenna worked perfectly! We predict that this "capacity antenna" will soon obsolete the present loop antenna, for many types of radio receivers!

## CONDENSER-LESS TUNING

Besides these features, our portable is built around the new Aladdin *permeability tuner*. The old variable tuning condenser can now peacefully repose in the "junk-box." Tuning is obtained by varying the inductance of the R.F. and oscillator coils through the medium of movable R.F.-iron cores.

The principle of permeability (inductance) tuning, is not new. It was used way back in the gay '20's in the form of

(\*) See "How to Make the 'Amplitenna' Capacity Aerial," *Radio-Craft*, February 1937.



# "PERMEABILITY PORTABLE"

or have your local Serviceman build it for you—and bring it along with you the next time hard to beat. The new type of built-in antenna eliminates the bother of winding a loop !!!

LESSEM

variocouplers, etc. (\*\*) However this is the first time that a really practicable unit has been successfully designed and made available to the public. The development of an iron core which can be used in coils at radio frequencies is mainly responsible for this achievement. By inserting or removing these cores, the effective inductance values of the coils are varied—making these coils and their associated circuits resonant to different frequencies. An ingenious lever system operates the iron cores.

## THE CIRCUIT

As can be seen from the schematic diagram, Fig. 1, the circuit is a conventional superhet., employing a type 1A7G tube as oscillator, mixer, and 1st-detector, a type 1N5G as 1st I.F., a type 1H5G as automatic volume control and 2nd-detector, and finally a 1A5G as power output. The use of permeability tuning together with iron-core I.F. transformers affords considerable overall gain, over the entire tuning range, which results in excellent volume. Selectivity is too good, being slightly better than 10 kc. This results in slight side-band cutting of the audio signal but is not serious at all. The circuit also makes use of its high sensitivity by employing the previously-mentioned "capacity antenna"—a built-in aluminum plate—for local reception. In suburban areas a larger antenna will be required to afford greater signal input. This may take the form of a 20 ft. length of wire strung

(\*) See "Permeability Tuning," Radio-Craft, Nov. 1931.

out on the ground and attached to an antenna binding post provided on the chassis.

The filament circuit is novel in that all tube filaments are connected in series and obtain power from a 6-V. battery. This enables us to take advantage of the voltage drop to provide a minus 4 V. negative bias voltage for the control-grid of the power output tube thereby eliminating the need for either a separate bias resistor or "C"-bias battery. However, more important, the use of a series filament circuit makes possible, if we so desire, to quickly and easily electrify the entire portable without any additional circuit changes. In a subsequent article we will give complete details for building a 1-tube power supply which furnishes both "A" and "B" power to any type of battery portable, including our Permeability Portable, using the 1.4-V. tubes.

## CONSTRUCTION HINTS

At the end of this article is a complete List of Parts used in the construction of our handy little radio set. Your author recommends that these parts alone and no substitutes be used if the same excellent performance of the original model is to be obtained. Don't use any "junk box" I.F. transformers. Use only those which come with the permeability tuner since they are specially matched. Do not fool with or attempt to "adjust" the iron cores in the permeability tuner. These are pre-set at the factory and should not be disturbed. Trimmer con-

## SPECIAL FEATURES

- Capacity Antenna!
- Condenser-less Tuning!
- Wide Wavelength Range (170 to 545 meters)
- Light Weight (6½ lbs.)
- Small Size (smaller than a Radio-Craft page, and 4 ins. deep)
- "Battery Bantam" (low-drain, small-space) Tubes

densers, mounted directly on the permeability unit, are used to align the coils.

Figures A and B show the front and rear view of the receiver and the locations of all the main components. The 1A7G and the 1N5G should be shielded (the shields are not shown in the photographs). The P.M. dynamic speaker is held in position by an aluminum bracket which also acts as a shield between the I.F. tube, and the 2nd-detector and output tubes. In Fig. B can be seen 3 tip-jacks mounted on the rear skirt of the sub-chassis. The 2 extreme jacks are used for both mounting onto and making connection to the self-contained metal plate antenna while the remaining jack is used for an outside antenna as explained in a preceding paragraph.

Complete specifications for drilling and punching the sub-chassis, speaker bracket and antenna plate are given in Fig. II. The holes for the sockets were punched out by means of an Amphenol type LD-1 socket-hole die. All other  
(Continued on page 168)

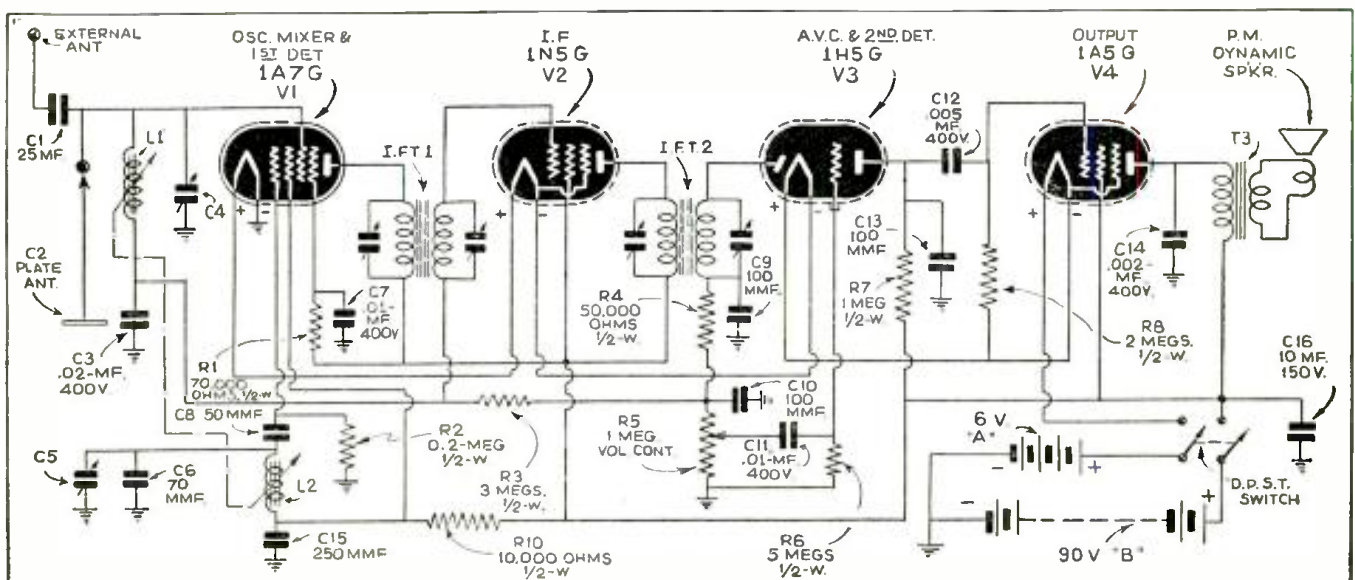
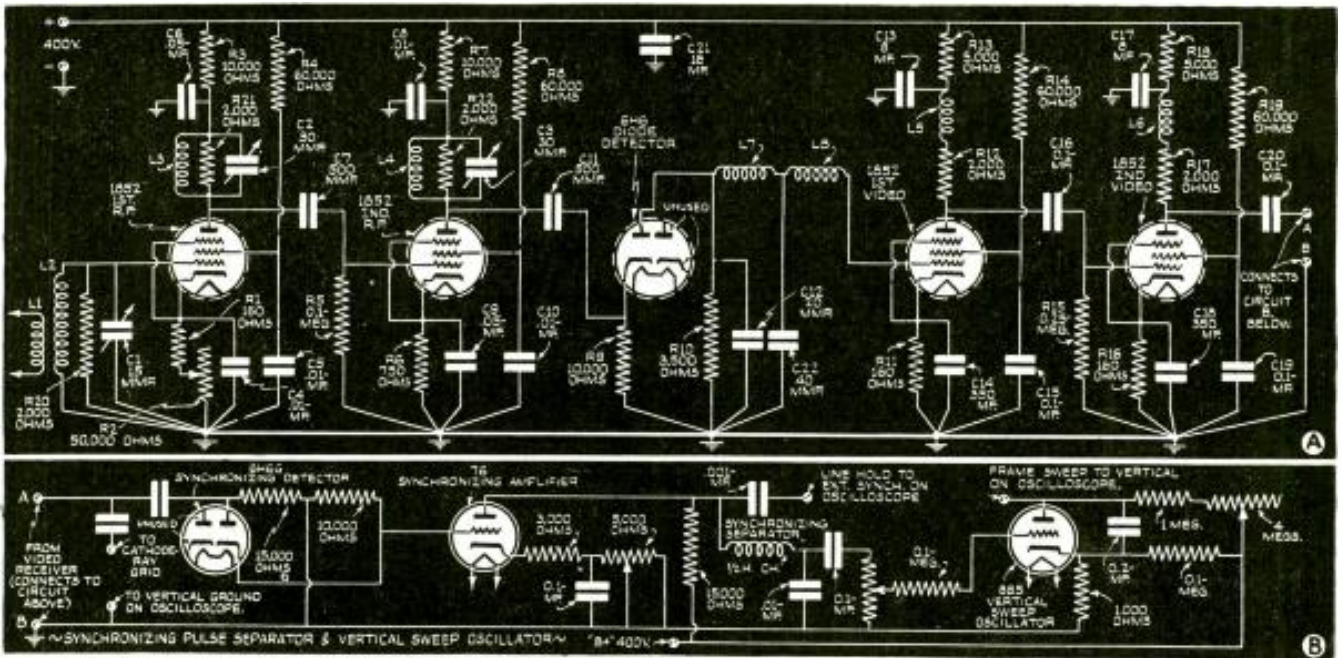

Fig. 1. Complete schematic diagram of the "permeability portable" battery receiver. Pay particular attention to the wiring of the filament circuit since proper "C" bias for the output tube depends upon it. C2 is the plate antenna which establishes a capacity to the chassis by virtue of its proximity to it.



Television-sight programs, amplified by a T.R.F.-type amplifier (A), are separated (B) into their video and sync-pulse components and fed into a service 'scope.

# TELEVISION EXPERIMENTS

Author Muniz—an operator at station WCNY (41.1 mc.) and instructor student Jerrier Haddad successfully concluded experiments along the CRAFT last year, which now make it possible for Servicemen to

RICARDO

## AT A GLANCE—

- 1—Uses only 8 tubes (plus power unit) and a standard 'scope.
- 2—Using a standard 3-inch service oscilloscope reduces hazards.
- 3—A simple T.R.F. Video tuner eliminates superhet. problems.
- 4—Experimental television for Servicemen now under \$100!

**H**ERE'S a simple television set-up which will enable you to receive television images on the window of *your servicing oscilloscope!*

It provides an opportunity to learn a great deal about television without spending very much money.

The procedure here outlined now makes it possible, for the first time, for the Serviceman to get into experimental television—study its principles at first hand, analyze its basic units, study its images under various test conditions—at a cost of well under \$100; this figure *includes* the average 3-in. service oscilloscope of good make which may be purchased for under \$60—and as this article is directed particularly to the tens of thousands of Servicemen who own service oscilloscopes, there's roughly \$60 "saved" right there, on the cost of trying out this thing called Television.

Naturally, better images can be obtained with a 5-in. 'scope than with a 3-in. one although the images obtained on the 3-in. one used by the author were

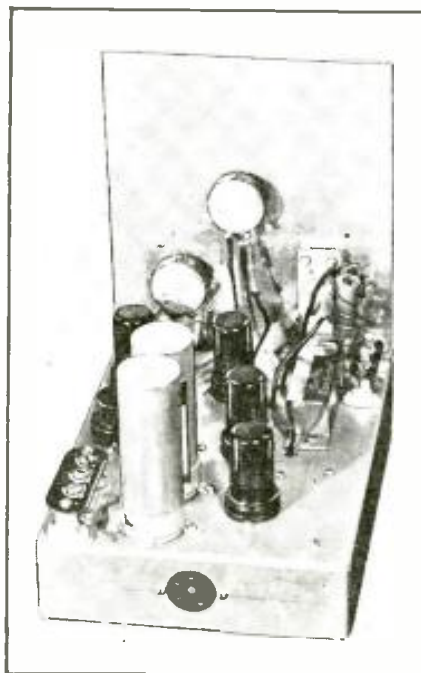

Rear view of the high-gain telly-sight amplifier.

quite clear. (Theory to the contrary notwithstanding!—*Editor*)

Experiments in this direction were initiated in the August, 1938, issue of *Radio-Craft*, but were suspended during the time prior to April 30 that N.B.C. was off the air.

## FEATURES

**Simple to Construct.** The circuit used in the design described in this article is not critical as to parts placement. Aside from the (easily compensated-for) effect of lead length on the number of turns on the R.F. coils the constructor can use his own chassis layout without mishap. It is recommended however that the layout shown in the photos be followed whenever convenient.

**Low Cost.** There are no "special" parts used. A well-stocked service shop or experimenter's laboratory will without a doubt have all the needed components (except, perhaps, the tubes) in its bins.

**Easy to Operate.** Once the initial adjustments have been made none of the controls have to be touched with the possible exception of the R.F. Gain which varies as the signal strength at different hours of the day. The trimmer condensers are brought out to knobs on the front panel for convenience but they need not be reset once adjusted; they are not tuning condensers—merely trim-



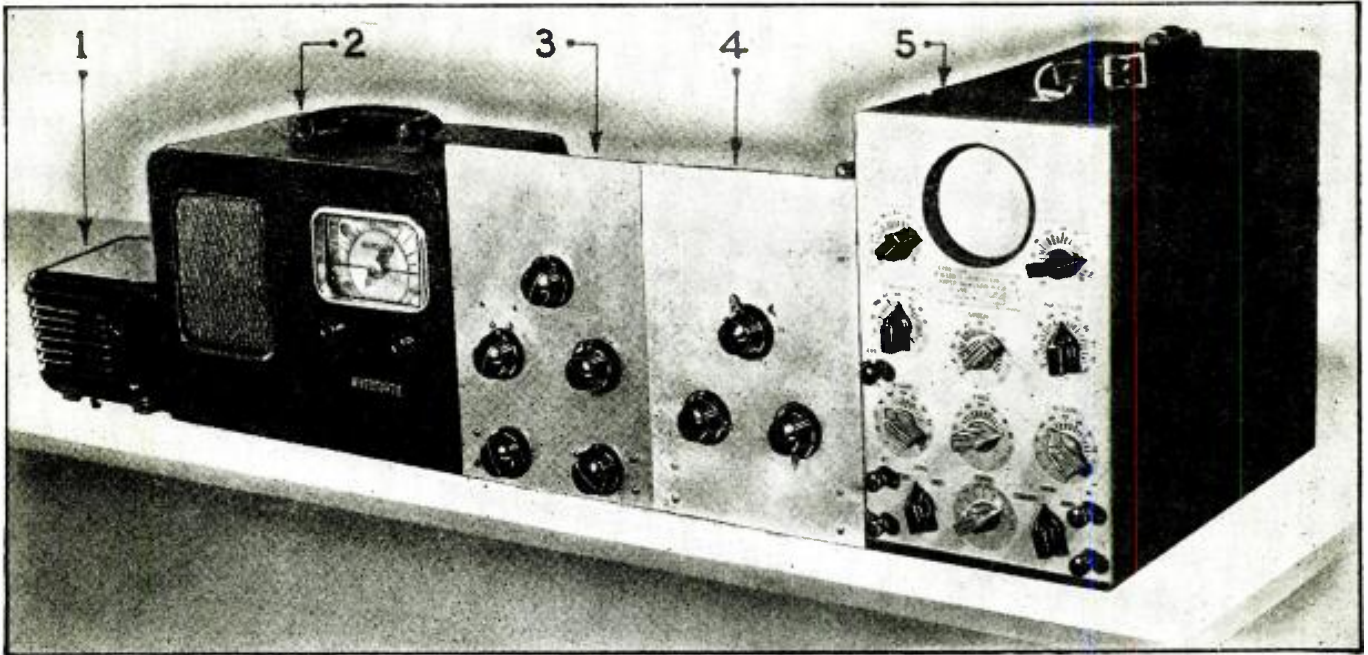

Sequence: the ultra-H.F. converter (1) feeds telly-sound into a battery-portable broadcast set (2); while a V.F. amplifier (3) feeds first a separator and oscillator (4), and then a service 'scope (5). (Power supply not shown.)

# WITH A SERVICING 'SCOPE

at Brooklyn (N.Y.) Technical High School—tells how he and Senior-lines suggested by Mr. R. D. Washburne, and initiated in RADIO-receive N.B.C.'s television programs at a cost well under \$100

## MUNIZ

mers. The coils are wound so that their inductance predominates and the tuning has almost been completed when the correct number of turns has been wound on these. Having the various controls readily accessible will, however, be a great boon to the experimenter or Serviceman anxious to learn all the ins and outs of television.

*Can Be Used Later with Larger Cathode-Ray Tube.* The receiver herein described has sufficiently wide frequency pass characteristics to permit the use of a 5-in. or 7-in. cathode-ray tube, with associated sweep circuits, if the experimenter should care to use it as a home receiver later.

### CONSTRUCTIONAL DETAILS

*Type Circuit.* A tuned-radio-frequency or "T.R.F." circuit was chosen to avoid the use of expensive, special wide-band-pass intermediate frequency transformers necessitated by the super-heterodyne type of circuit. A diode detector is used because of its fidelity. A triode could have been used with a gain in sensitivity but a sacrifice in band passed. The set has proven more sensitive than we ever dreamed it could be. The video amplifiers are compensated to improve their band pass characteristics.

*Coil Turns vs. Length of Lead.* In all ultra-high-frequency circuits the value of the distributed constants such as

leads, etc., is of as great importance as that of the lumped constants such as coils, condensers, etc. This is especially true of the leads carrying the 45.25 megacycles (for N.B.C., for example) in the telly receivers. It will be found that while the number of turns on the R.F. coils specified is exactly correct for the layout used by the author it will not be correct for other layouts. The trimmers have a tuning range equivalent to about 1½ turns on the associated coil so that it will be easy for the experimenter to work on the coils. If a design using shorter leads is used try adding 1 turn to each coil, and vice versa.

*R.-C. Decoupling Filters.* It will be noticed that each stage is provided with resistance-condenser decoupling filters

and that the detector makes use of one having coils and 1 condenser. In the R.F. end these prevent oscillation due to interstage coupling via the "B+" lead.

The plate tuned circuits have an impedance of approximately 1,000 ohms and are shunted with 500-ohm resistors so that considerable R.F. would get into the "B+" right there unless decoupled. The detector is filtered to prevent any 45.25 mc. "stuff" from getting into the videos.

(Continued on page 176)

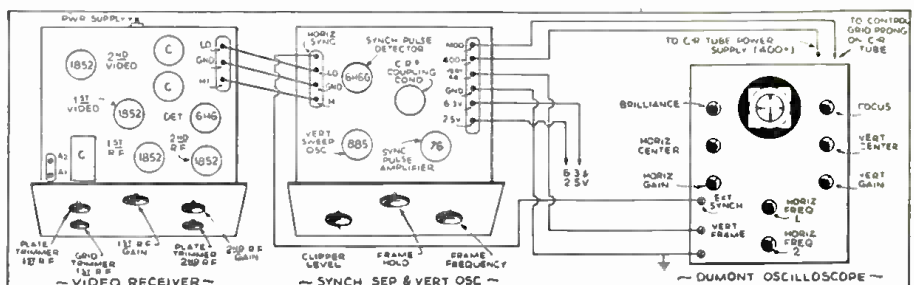

Connections and tube locations. Utilizing a manufactured service 'scope eliminates dangers of exposed high-voltage wiring, and saves much time and labor.

# 1st GROUP of PRIZE WINNERS

## Radio-Craft's P.A. Contest

Servicemen, radio dealers and sound specialists are here given the article which won the 1st Prize in the initial Section of RADIO-CRAFT'S \$4,000 P.A. Contest. The winner's contribution shows how an original technical idea made it possible to sell several profitable sound installations in competition with competitors who bid lower prices. Also presented here are the names and addresses of the remaining winners of Section No. 1 in this Contest.

**1ST PRIZE**—100-W. Complete P.A. System, type 42-75, \$262.55.

Offered by Vocograph Sound Systems

Won by R. H. Lehfeldt, Flagler Radio Co., Inc., 1068 West Flagler St., Miami, Fla.

**2ND PRIZE**—18-24 W. Complete Mobile P.A. System, \$149.40.

Offered by Lafayette Radio Mfg. Co.

Won by M. C. Turner, Precision Radio Service, Langdon, N. Dak.

**3RD PRIZE**—25-W. Complete Mobile P.A. System, \$120.00.

Offered by Allied Radio Corp.

Won by Gordon F. Brown, Xpert Radio Service, 39 South Fifth Ave., Tucson, Ariz.

**4TH PRIZE**—19-W. Micro-Beam Amplifier, type ACA-19C, \$75.00.

Offered by Amplifier Company of America.

Won by Leroy Peters, 707 South 5th St., Lindenhurst, N. Y.

**5TH PRIZE**—15-W. Deluxe Amplifier, type A M - 15, \$57.00.

Offered by Amplitone Products Company.

Won by Joe D. Kline, Osawatomie, Kans.

**6TH PRIZE**—8-W. Complete Portable P.A. System, \$54.20.

Offered by Radolek Company.

Won by William Robinson, Hill Radio Sales & Service, 523 Joralemon St., Belleville, N. J.

**7TH PRIZE**—Velocity Microphone, type RBHK, \$42.00.

Offered by Amperite Company.

Won by F. R. Hills, 2239 Toronto St., Regina, Sask., Canada.

**8TH PRIZE**—400-V. High - Power Genemotor, 175 ma. for Portable Amplifier, 6 V. Output, type 415A, \$40.00.

Offered by Carter Motor Company.

Won by M. C. Turner, Precision Radio Service, Langdon, N. D.

**9TH PRIZE**—4½-Ft. Air Column Trumpet, \$32.50.

Offered by University Laboratories.

Won by Roy Ratliff, Radio Service Dept., Santa Fe Motor Co., 418 Cerillos Rd., Santa Fe, N. M.

**10TH PRIZE**—Carbon Microphone, type 99, \$30.00.

Offered by The Lifetime Corp.

Won by J. A. Houser, J. Houser & Co. Enterprises, Rutland, Vt.

**11TH PRIZE**—Auto-top Carrier for Mobile Sound Installations, Platform Size, 30 x 54 ins., type PA26, \$22.50.

Offered by Vac-O-Grip Company.

Won by W. K. Winterbottom, 527 Broad St., Oxford, Pa.

**12TH PRIZE**—Auto-Top Carrier for Mobile Sound Installations, Platform Size, 30 x 54 ins., type PA26, \$22.50.

Offered by Vac-O-Grip Company.

Won by Chris Palgen, Clarmont Radio Co., 6011 Cottage Grove Ave., Chicago, Ill.

**13TH PRIZE**—12-In. P.M. Speaker, type FB12-M, \$15.50.

Offered by Cinaudagraph Corp.

Won by J. A. Houser, J. Houser & Co. Enterprises, Rutland, Vt.

## THIS IS THE FIRST PRIZE MANUSCRIPT

Public Address Contest Editor,  
Radio-Craft Magazine,  
99 Hudson St.,  
New York, N. Y.

Dear Sir:

Find attached (page 189) my entry

to your P.A. Contest. This particular job was installed for the opening of "THE DRUM" a supper club, on Dec. 10, 1938.

While my inability to draw diagrams (shown below, redrawn.—Editor) sim-

ply may make this seem complicated it is a layout for the average club found in any city. Freedom from trouble, flexibility and successful operation by inexperienced employees make this our outstanding job.

I believe that manufacturers should design amplifiers to facilitate instant change-over systems; do not confuse this with the "binaural" systems or a single amplifier with 2 input channels as there are actually two separate, identical amplifiers (one in use and one spare). In two cases since our installation in "THE DRUM" we have sold these instant change-over systems; in both cases our bid for the job was much more than that of our nearest competitor. It seems that they do not know how we made the sale (which makes me think that when I lose a sale I should find out why; in order not to be caught napping next time).

Yours truly,  
FLAGLER RADIO COMPANY, INC.,  
R. H. Lehfeldt, Pres. & Design Eng.  
(Continued on page 189)

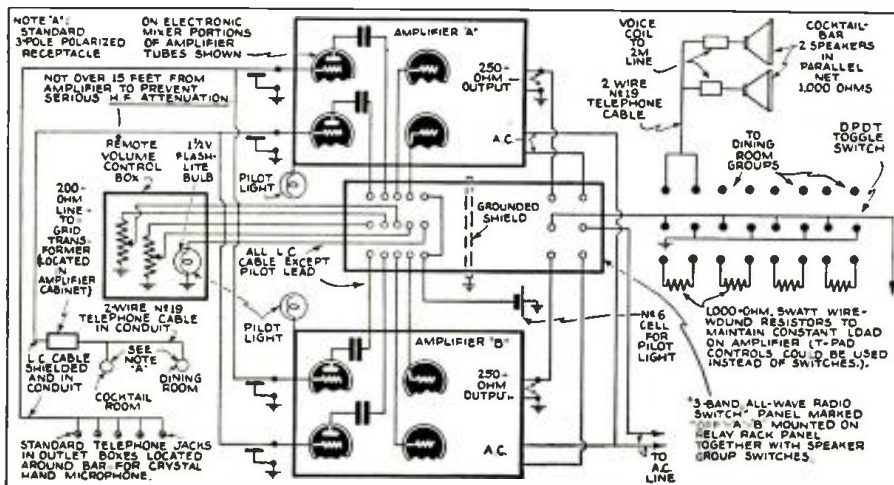



# 9 New Tubes

Electronic developments this month make possible heretofore unattainable results in radio transmission and reception, and television. The forerunner of what the author believes is a new line of tubes with filaments which connect directly to the light-line is described.

R. D. WASHBURNE

**T**HIS month's crop of new tubes covers the fields of television (both receiving and transmitting), broadcast receivers, high-frequency transmitting, and hearing aids.

By far the most outstanding of these new tubes is the Sylvania high-vacuum full-wave rectifier which is designed to operate with the filament connected directly across the 117-V. A.C.-D.C. electric power lines! The writer believes that this tube is the forerunner of an entire line of 117-V.-filament tubes—all operating directly from the electric light line; and that within about a month an output power tube will be introduced, in this new "direct onto the light line"-filament type of construction, which requires no power-cord resistor or ballast tube in series to drop the voltage, but which utilizes all the filament current.

Then there is a cathode-ray tube with an absolutely flat viewing screen and "ion trap" (anti-blemish construction); a group of single-ended pentagrid converters and a diode-triode pentode; 2 new Iconoscope television tubes; and, a midget ultra-high-frequency transmitting tube which outputs 50 watts on 200 megacycles.

## 117-V.-FILAMENT TUBE

**117Z6G—High-Vacuum Full-Wave Rectifier**  
Hygrade Sylvania leads this month with a new high-vacuum, full-wave rectifier tube having a 117-V. filament.

Each of the 2 plates has its own cathode and filament, as usual, and also as usual the 2 filament sections are connected in parallel, but each filament section is center-tapped. The center-taps of the filaments are brought out to pin No. 1 so that it is possible to operate the filaments in parallel on 58.5 V. With this connection the heater current is 150 milliamperes whereas when operated on 117 V. it is only 0.075-ampere.

This matter of obtaining sufficient resistance to achieve this low current drain at such high terminal voltages, and yet secure sufficient filament heat to assure adequate cathode radiation, presented a problem which required an entirely new manufacturing procedure.

The solution was eventually found in the construction illustrated in the illustration at top-right, on this page. A high-resistance filament, heavily insulated to withstand

breakdown at the peak voltages which might be encountered under all types of operation (as for instance operating the tube on the "high" side of a 3-wire power system having possible peak voltages-to-ground in the region of 450 V.), is folded back and forth to make a bundle of 15 folds, center-tapped. Two such filament bundles are then slid into emitter-coated metal cathodes; the usual ceramic cathode is not needed since the filament wire is insulated. This filament insulation is obtained by a special process of 8 alternate immersions in a solution and of baking this chemical onto the filament wire.

The Serviceman encountering one of these 117Z6G's for the first time, and closely examining it, would ordinarily get the (erroneous) impression that the filament is shorted upon itself at every fold, and that the filament is shorting directly to the metallic-tube cathode. The answer is that, as described above, the filament is an insulated wire.

Conventional rectifier circuits may be employed but care should be taken to insure that the maximum current and voltage ratings are not exceeded. See Table I for specifications.

## TELLY RECEIVING TUBE

**New (Philco) Cathode-Ray Tube Has Flat End and Ion Trap (Anti-Blemish Gun Placement)**

There are 2 major defects with the conventional cathode-ray telly receiving tube which are most apparent to the layman. They are: (1) the "onion-shaped" end which makes possible only a limited angle for viewing the image; and (2) tube blemishes caused by bombardment of the screen by ions in the electron stream.

The first of these defects is now entirely eliminated by the development of a new type of C.-R. tube which has an absolutely flat viewing-end, Philco Radio & Television Corp. reported last month. Elimination of the second defect, the ion nuisance, is accomplished as follows:

The electron gun is placed slightly off-center so that the beam of electrons normally instead of hitting the center of the viewing screen now hits one side of the screen. An extra deflecting plate or yoke, however, is used to bring the beam back to  
(Continued on page 186)

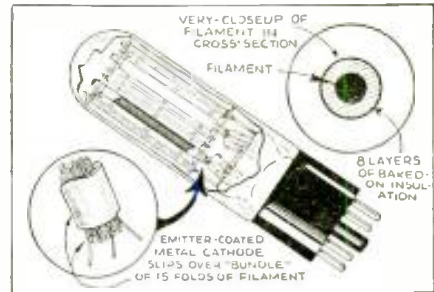

New 117-V. filament rectifier. It's the author's belief that within about a month an output power tube will be introduced, in this new "direct onto the light line"-filament type of tube.

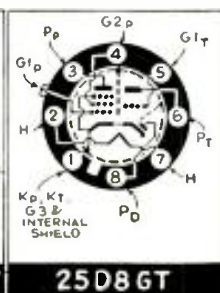
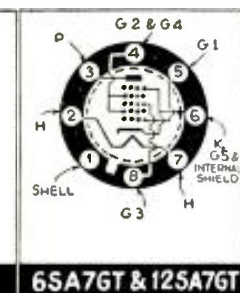
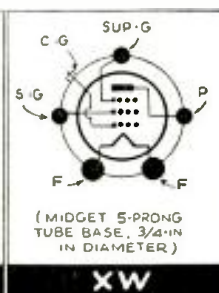
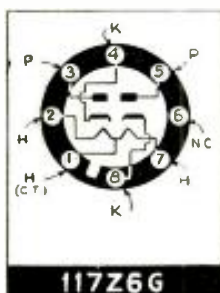
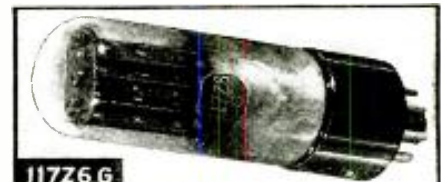



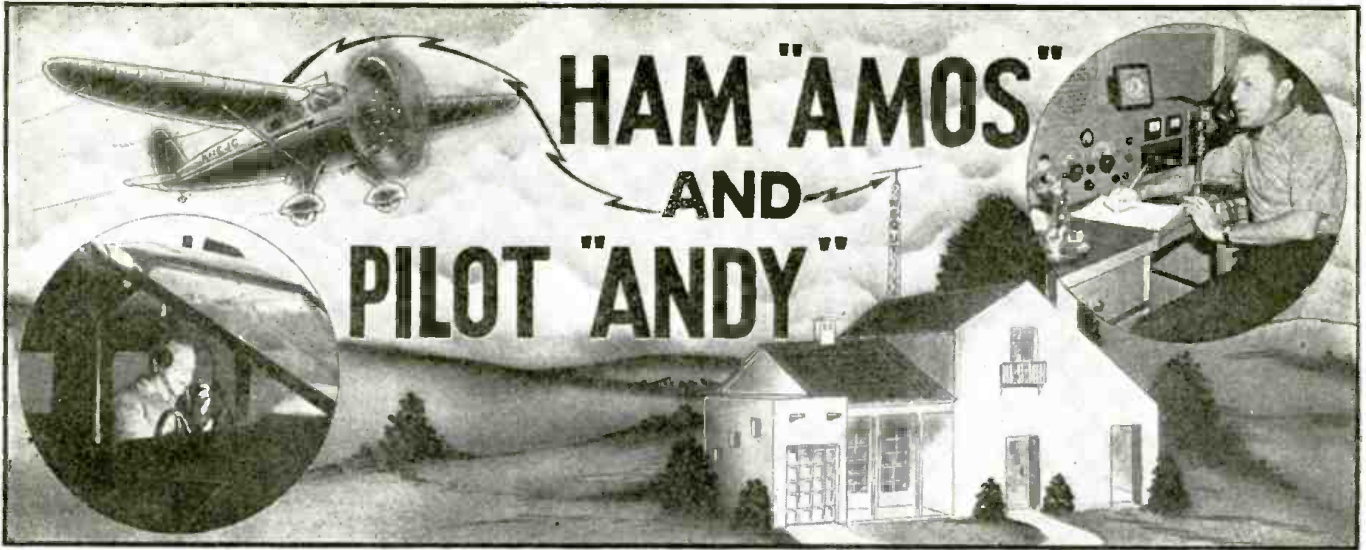

The well-known Negro impersonators and radio comedians, Amos 'n' Andy, contact each other via radio while pursuing their respective hobbies. Radio amateur Amos, W6QUT, may contact pilot Andy, KHCJC, but Andy may not talk back inasmuch as he is not an amateur. He merely flips his wing in answer.

*"Andy" may rib "Amos" on the air, during their C.B.S.-net programs, but "Amos" chaffs "Andy" in the air. The 10-meter ham station of "Amos" also enables him to relay the voice of "Andy's" father at home in Illinois to his son in the California skies.*

**T**HE only way Freeman F. Gosden, who plays "Amos" in Columbia's famous "Amos 'n' Andy" team, can turn the tables on his old pal "Andy," over the air is via amateur radio. From 7:00 to 7:15 p.m. each weekday night, "Andy" is "Amos'" boss. But once their network program is over, "Amos" becomes top dog—on the 10-meter band.

It happens this way. Charles J. Correll ("Andy") likes to fly. He has his own plane. In it is a shortwave set, KHCJC, which, as a licensed pilot, he is permitted to operate. He uses it for navigation purposes. But he is not permitted to talk into its microphone on any personal matters.

That's where Gosden ("Amos") comes in. For Gosden is also a radio "ham." He has a shortwave set in his automobile, and at his home. And he is allowed to talk to anyone he likes.

As soon as he knows Correll ("Andy") is going aloft, Gosden rushes to his home transmitter, W6QUT, and contacts Andy's station in the air.

"Hi!" he greets his friend, in the language of the shortwaves. "This is Amos Jones speaking—and he's the Kingpin now!" Then, with high glee, he kids the life out of the silent Correll, who has to listen to it all over his flying receiver, without saying a word.

Correll takes it like a sport, however, especially since it's all good-natured kidding on Gosden's part. As a matter of fact, the boys have quite a few odd confabs between the sky and the ground. One of the most popular tricks Gosden has is to contact a "ham" in Peoria, which is Correll's home town. This amateur goes out and brings in Correll's father. The elder Correll then goes on the air, with any messages he wants to send his son, Gosden relays

them from W6QUT, and Correll picks them up over KHCJC in his plane. He can't answer, but to show he's heard the messages, he flips his plane's wings, or otherwise maneuvers in the air according to Gosden's instructions.

And Gosden passes this signal back to Mr. Correll in Peoria.

Gosden, who is much more enthusiastic about "ham" radio than Correll, has put plenty of care, cash and consideration into equipment for W6QUT. In his radio shack, he has a Collins 30J transmitter, with an output rating of 250 watts, a DB20 preselector, and an RME69 receiver. On his roof there is a 3-element, close-spaced, rotary beam which is motor driven. He operates on the 10-meter band, at 28.52 megacycles.

A feature of Gosden's radio shack is a large flat map of the world, which has been issued by the American Radio Re-

*(Continued on page 167)*

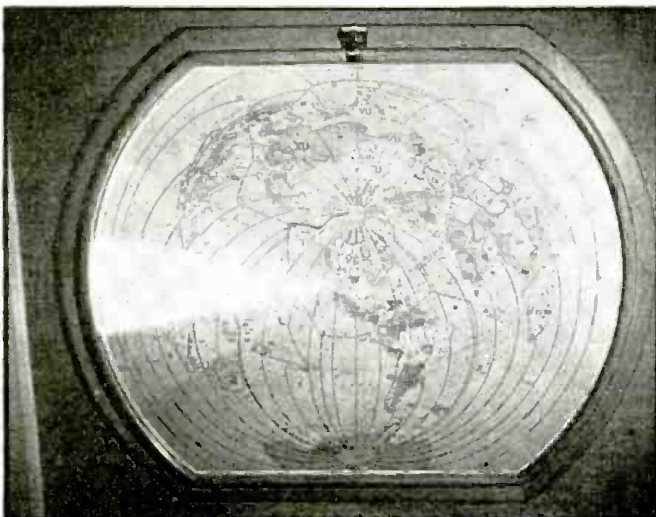

A feature of Gosden's (Amos') radio shack is this large map of the world, issued by the American Radio Relay League. The beam of light is synchronized with his roof-top rotary antenna to show which way it is sending signals!



Gosden as amateur station W6QUT boasts of de luxe rigs. In a radio shack at his California home he has a fine transmitter and receiver; in his car he has a 15-W. S.W. transmitter, a "B.C." receiver, and an S.W. converter.





You're looking at the extravaganza of sound, fire and water at the New York World's Fair, through the windows of the "cue" (control) room atop the Rumanian Pavilion. Twenty tons of water, 2,000 watts of sound, 1/2-million cubic feet of gas and many rounds of fireworks are all controlled from this nerve center.

## 3-DIMENSION 2-KW. P.A. AT N.Y. FAIR

The world's No. 1 scenic attraction, the nightly Ballet of Fountains in the "World of Tomorrow," has brought outdoor use of super-power 3-dimension sound.

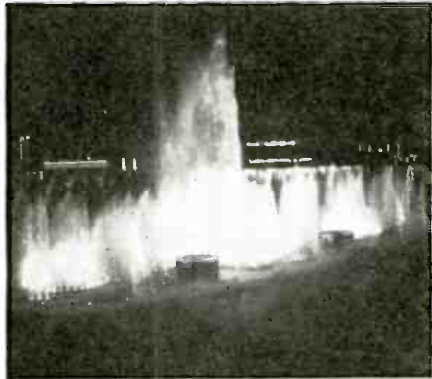

**P**ROBABLY the most outstanding sound installation at the New York World's Fair, or for that matter, in the world of today, is in the much talked-of Lagoon of Nations. As dramatic as any Fair exhibit, this installation demonstrates the possibilities of modern, 3-dimension sound equipment as the "Sound System of Tomorrow."

Eight projector units, especially designed for this installation

◀ The nightly ballet of water, fire and sound in full swing at the New York World's Fair.

(\*) See "The Third Dimension in Music," Radio-Craft, May 1934; and, "Elements of 4th Dimension P.A. or Sound Systems," Radio-Craft, Parts I and II, Jan. and Feb. 1935.

by Cinaudagraph, handle the output of a 2,000-watt amplifying system, distributing concert music to a crowd which at times numbers more than 300,000 people.

So great were the problems presented by the Lagoon of Nations installation that many leading authorities in the field believed them to be insurmountable. Here was a vast oval lagoon (previously a mud slough over 60 ft. deep in slime!—*Editor*), planned as the setting for a mighty nocturnal symphony in which, perhaps for the first time in the history of the world, music and the Elements—fire, water, light . . . even thun-

(Continued on page 172)

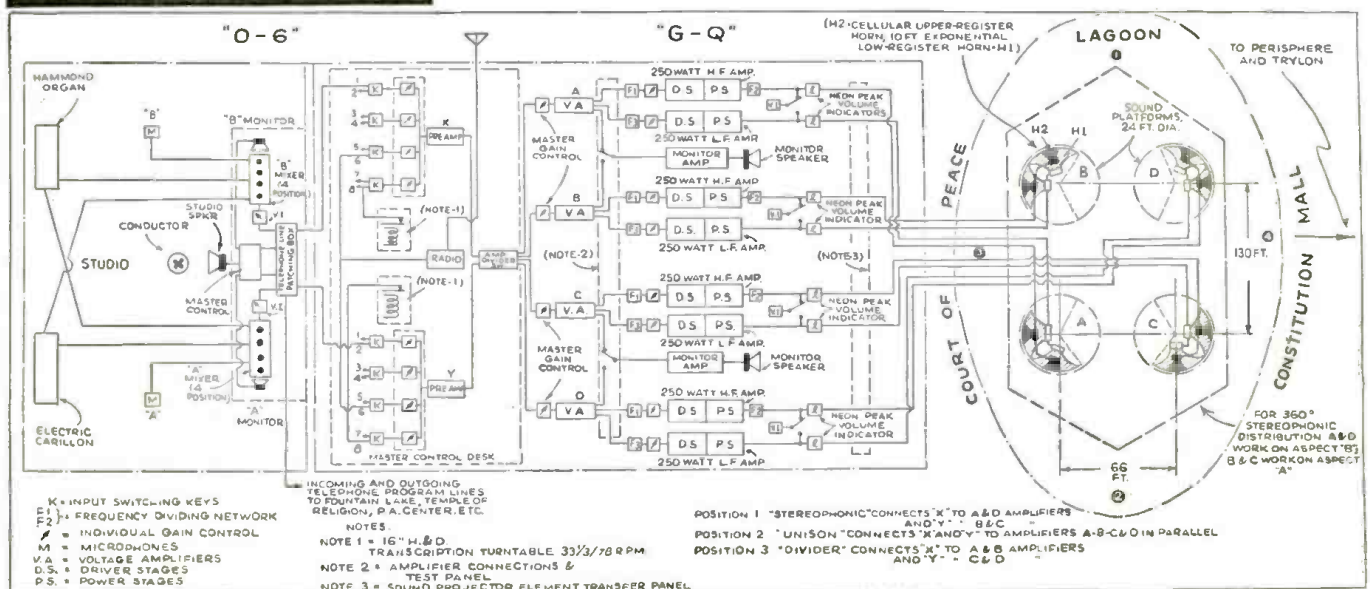

Block diagram of the electro-acoustical system for stereophonic, 360-degree distribution of music at the Lagoon of Nations, New York World's Fair, 1939.

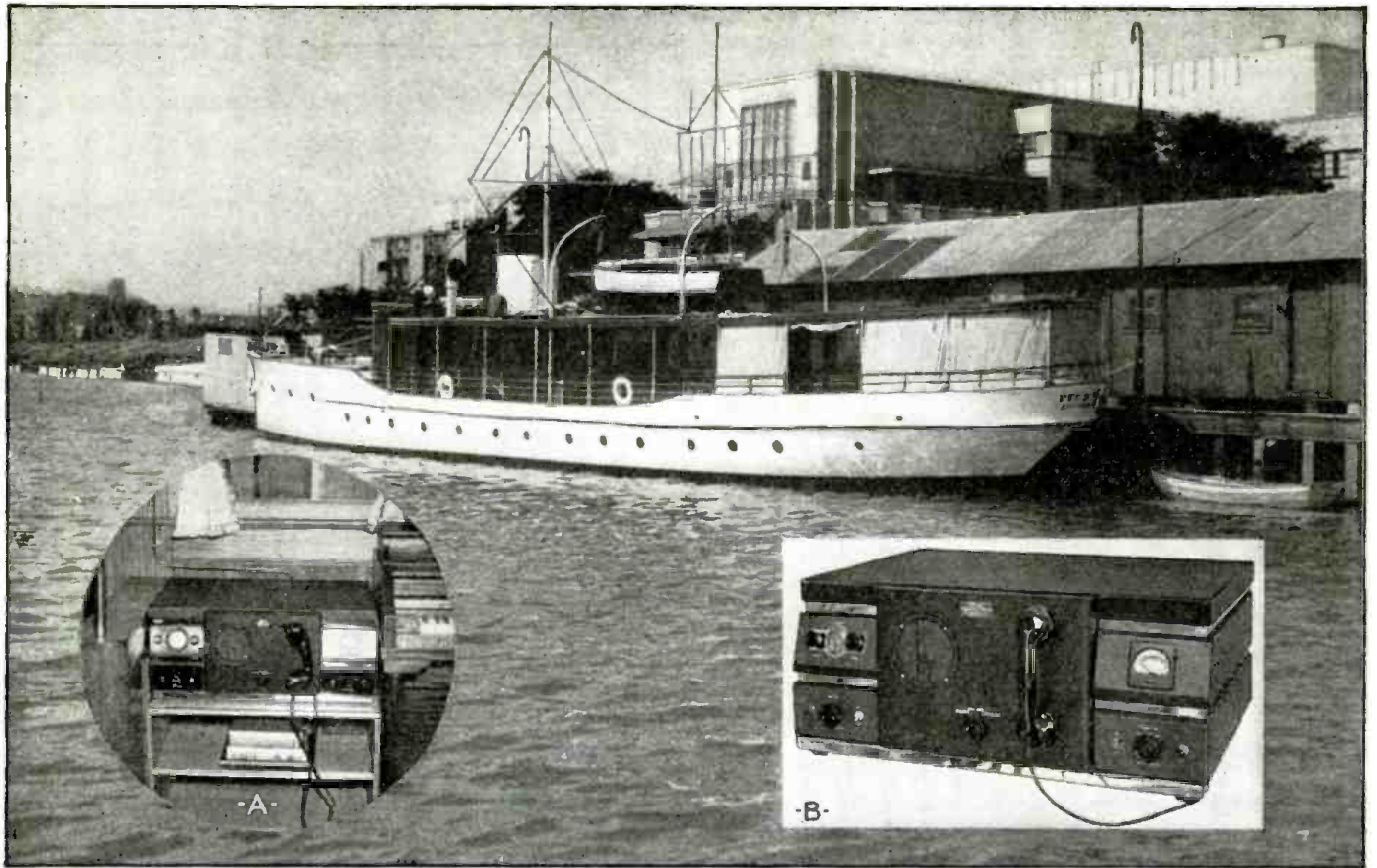

Telephone service at sea for small and large boat owners. Inset A shows typical installation in the boat illustrated above. Inset B is a close-up view of the equipment.

# MARINE RADIO TELEPHONE—

*Servicemen looking for new fields to conquer will do well to look into the instal-Radiotelephony for both large and small boats. Servicemen living near either coast*

S. GORDON

**W**HEN an experimental system of "Harbor" radio was announced a few years ago (\*) it was greeted with wide acclaim in newspapers and periodicals as being the solution of the communication and safety problem of boats too small to support a commercial radio installation and salaried operator. Since that time, strangely, little has been heard about it in spite of

\*See "Harbor Radio Telephone Service," Radio-Craft, Nov. 1936.

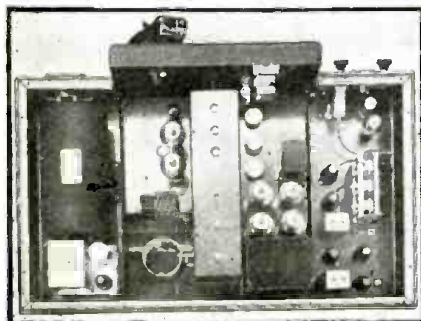

Inside view of the complete marine telephone equipment; transmitter (center), receiver (right), and power supply dynamotor (left). This is a Hallicrafters model HT-3 unit.

the fact that it has in the meantime developed into a regularly established service.

With suitable equipment on board (which, unlike the usual ship installation, does not require the attendance of a technically-skilled commercial operator) a boat can cruise at will along the U. S. coast with assurance that at 'most all times and with normal atmospheric conditions it will be able to:

- (1) Hook-up with a shore marine-telephone exchange and through this exchange be connected to any desired land phone;
- (2) Communicate directly with other similarly-equipped boats within range;
- (3) Communicate with any point which could normally be reached by a land phone, including foreign countries and ships at sea;
- (4) Communicate either direct or through the shore station land wire system with the nearest Coast Guard station in case of emergency;
- (5) Receive calls as well as make them.

## SERVICEMEN PLEASE NOTE

From the standpoint of the Serviceman who is located at a seaport, installation and maintenance of such ship's equipment offers a growing opportunity. Especially so if he is a licensed commercial operator as well. Any Serviceman can service this equipment, or install it. He can test it and adjust its frequency with a dummy antenna, but he cannot, however, test it on the air nor can the owner again put it on the air. Only a holder of the necessary license mentioned above can do that. If the Serviceman or owner is not himself such an operator he can perhaps find one in the vicinity who is willing to work with him.

If you, Mr. Serviceman, are interested in this type of work, there are two ways of digging up business. One is to contact local yacht basins, repair yards or supply houses. The other is to establish contact with manufacturers of such equipment, providing proof of your knowledge and ability to handle installations and service with the object of having them turn over to you any inquiries coming from your territory. If you are



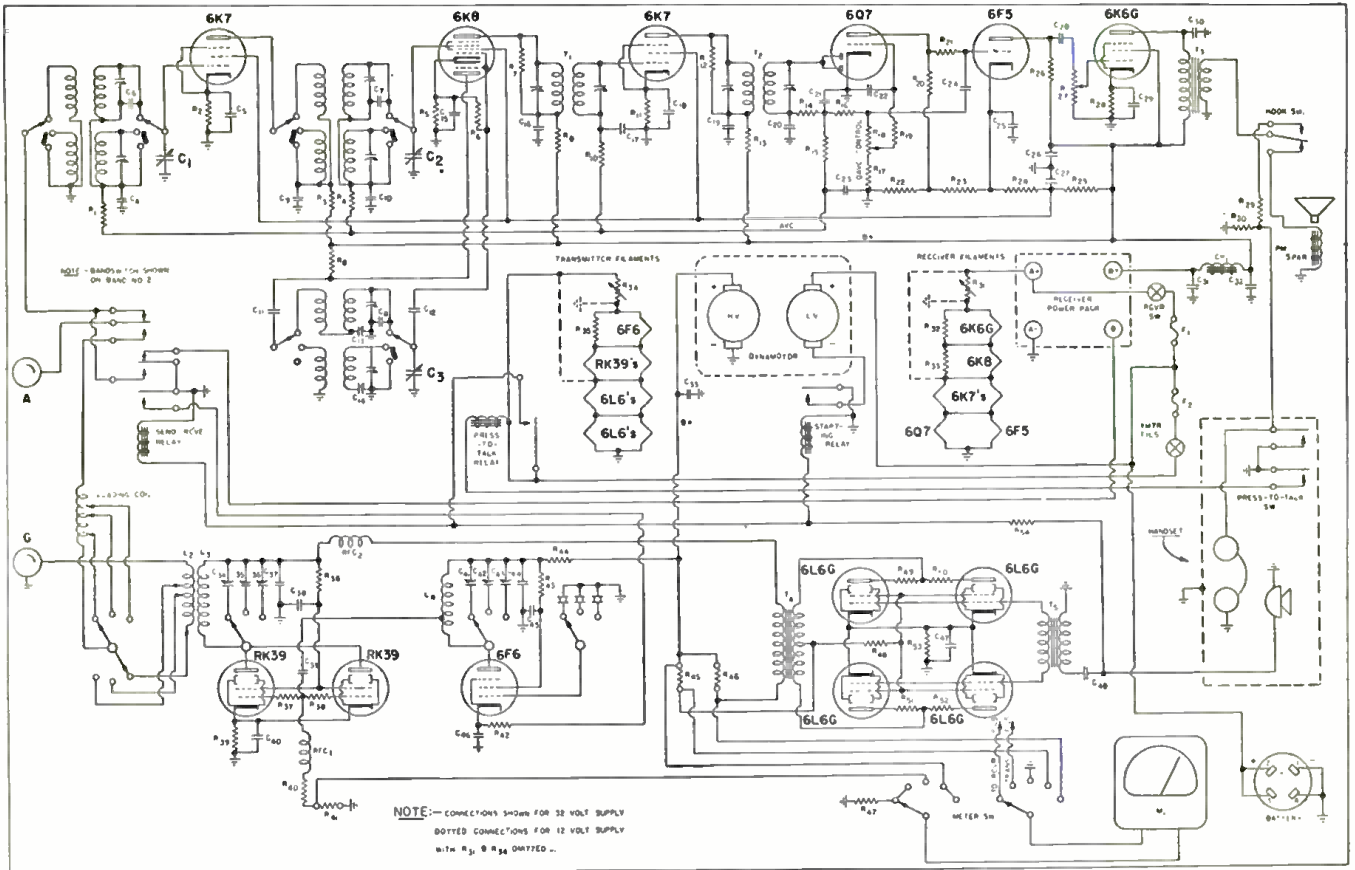

Fig. 1. Schematic diagram of the Hallicrafters HT-3 marine radio telephone. Values for resistors and condensers are given below in extreme right-hand column.

# Latest Field For Servicemen

lation and service possibilities presented in the rapidly growing field of Marine or "The Lakes" we feel sure will welcome Mr. Taylor's meaty article.

## TAYLOR

a "han" it will help toward this end; if you hold a 1st Class or 2nd Class commercial ticket—or if you have held such tickets—it will help still more.

The advantages of a marine telephone system are too obvious to require elaboration. That the system is practical is evident from figures of the New York marine-telephone exchange which show the number of calls handled in recent months to be 4 times greater than a year ago!

To provide the backbone of the service the Bell Telephone System has established East-coast marine-telephone exchange stations at Boston, New York, Norfolk and Miami; 3 on the west coast, at Los Angeles, San Francisco and Seattle; and proposes to install one more at Charleston, S. C., to complete coverage of eastern coast waters, and others at New Orleans and Galveston to extend the service area along the Gulf coast.

The transmitters at these stations use several hundred watts in the antennas. Because the equipment on boats is necessarily limited in power by their supply sources, the Bell System has established auxiliary receiving stations to

pick-up and relay over land wires signals from boats too distant from the main stations to maintain direct, dependable contact with their lower power.

## REQUIREMENTS

The Telephone Company has nothing whatsoever to do with the equipment installed on boats. This is selected and purchased by the boat owner. It is, of course, subject to the rules and regulations of the Federal Communications Commission and must meet the usual requirements governing frequency stability, modulation percentage, etc. These regulations are more lenient than those applying to regular commercial ship equipment in the respect that the operator need have only a 3rd Class commercial license, to obtain of which the requirement is a knowledge of rules and regulations governing radio communication rather than knowledge of technical subjects.

The station on board a boat must be licensed in the usual way, and is assigned call letters. The preliminary adjustment and tuning of the transmitter

(Continued on page 180)

## SCHMATIC VALUES

Condensers (Values in mf., and 400 V., except where otherwise indicated.)

- C1 C2, C3—3-section variable condenser, 408 mmf. per section
- C4—0.05-400 V.
- C5—0.1-200 V.
- \*C6—175 mmf.
- \*C7—175 mmf.
- \*C8—175 mmf.
- C9—0.05-400 V.
- C10—0.05-400 V.
- C11—0.002-400 V.
- C12—100 mmf.
- C13—Variable Pad
- C14—Variable Pad
- C15—0.1-200 V.
- C16—0.05-400 V.
- C17—0.05-400 V.
- C18—0.1-200 V.
- C19—0.05-400 V.
- C20—100 mmf.
- C21—100 mmf.
- C22—0.01-400 V.
- C23—0.05-400 V.
- C24—0.01-400 V.
- C25—20, 150 V. Elect.
- C26—2, Parallel, 0.05-400 V.
- C27—0.1-200 V.
- C28—0.01-400 V.
- C29—20, 150 V.
- C30—500 mmf.
- C31—15, 450 V.
- C32—15, 450 V.
- C33—2, 1,000 V.
- C34—520 mmf.
- C35—365 mmf.
- C36—365 mmf.
- C37—0.002-2,500 V.
- C38—0.002-2,500 V.
- C39—0.001-900 V.
- C40—0.006-900 V.
- C41—100 mmf.
- C42—100 mmf.
- C43—100 mmf.
- C44—0.002-900 V.
- C45—0.002-900 V.
- C46—0.006-900 V.
- C47—20, 100 V.
- C48—0.25-600 V.

\*Ceramic  
Resistors (Values in ohms, and 1/2-W., except where otherwise indicated.)

- R1—0.1-meg.
- R2—300
- R3—10,000
- R4—0.1-meg.
- R5—300
- R6—50,000
- R7—0.5-meg.
- R8—50,000, 1 W.
- R9—10,000
- R10—0.1-meg.
- R11—500
- R12—0.5-meg.
- R13—10,000
- R14—20,000
- R15—0.5-meg.
- R16—0.25-meg.
- R17—50,000
- R18—50,000, Pot.
- R19—1 meg.
- R20—1 meg.

(Continued on page 181)

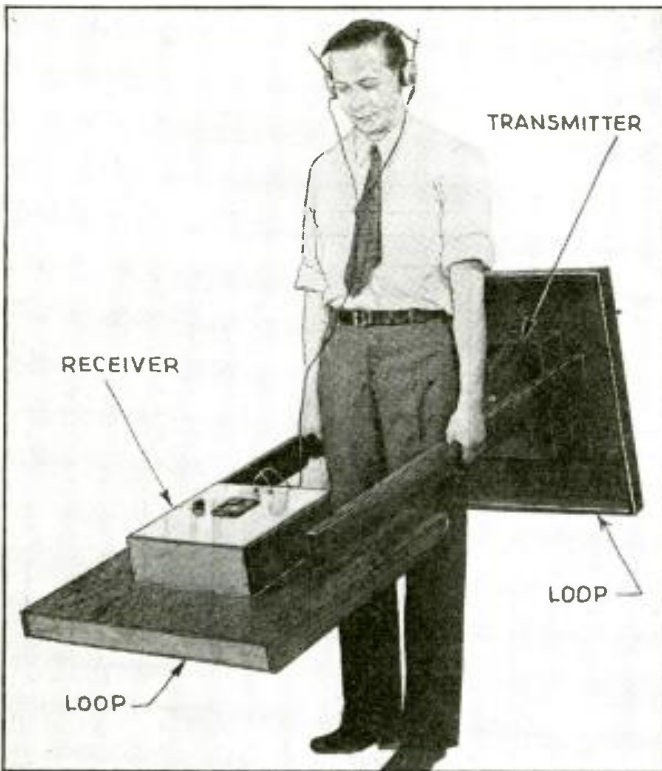

The Radio Treasure Locator in operating position. It gives both visible and audible indication of the presence of metal. It is simply constructed, without fancy trimming—but efficient in operation.

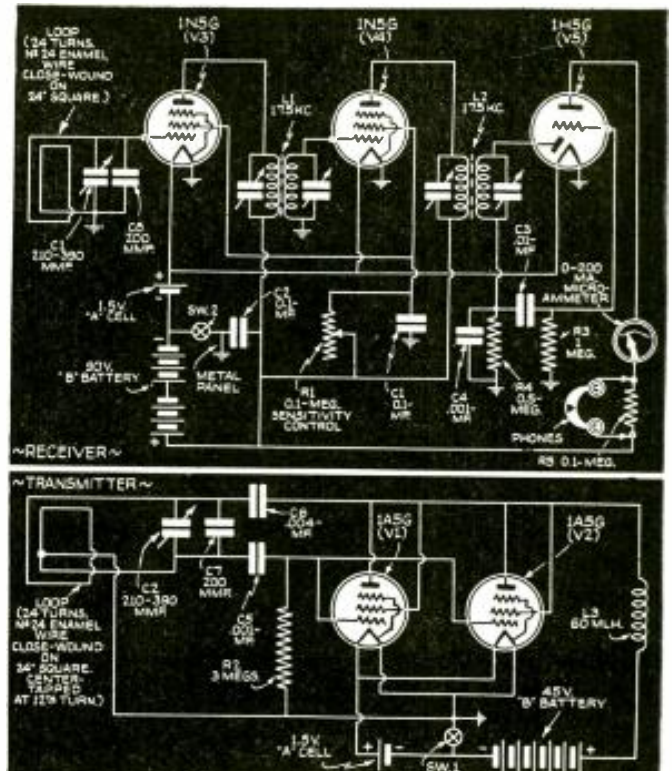

Fig. 1 (top). Schematic diagram of the receiver. Three 1.4-V. low-drain drycell tubes are used. Fig. 2 (above) Schematic diagram of the simple transmitter. These simple circuits provide fool-proof operation.

# HOW TO MAKE A MODERN

*Such a great amount of interest in so-called Treasure Locators has been the author to develop a modern, portable and highly-sensitive instrument, which*

ALLAN

**A** SEARCHING study of all available data on previous treasure locators revealed that many limitations were imposed on these outfits by the lack of low-drain tubes, by the size and weight of "A" and "B" batteries, by low sensitivity, and in many

cases the necessity of having to use hundreds of feet of wire and two or more operators.

Most of these limitations have been removed entirely from this newest treasure locator—see photo at upper-left corner of this page—as will be shown.

## MODERN DESIGN

The instrument comprises 3 parts: (1) the receiver, (2) the transmitter, and (3) the framework. The receiver, see Fig. 1, operates as a high-gain I.F. amplifier of 2 stages, with a tuned loop-antenna input. A diode detector and triode A.F. amplifier are used in the output with both phone and meter indicator. The 3 tubes are of the 1.4-volt filament type with a total drain of 150 ma. of "A," and only about 3 milliamperes of "B" thus assuring long life to the single drycell and the 2 lightweight, compact "B" batteries. The overall sensitivity may be varied and at maximum is about 10 times greater than previous instruments of

this type!

The transmitter, Fig. 2, consists of 2 drycell-type output pentodes connected in triode fashion and in parallel for greater power. Loop radiation and self-modulation combine to make a powerful and stable oscillator which is "easy" on the single "B" battery. Here, too, a single drycell serves to light the low-drain filaments.

The framework consists of two 4-foot handlebars to which are attached the receiver and loop frame horizontally, at the front end, and the transmitter and loop frame, vertically, at the rear. The operator wears the headphones and watches the meter while carrying the unit about.

## OPERATION

The principle of operation is simply that the radiated wave from the transmitter loop is directed into the earth and if the wave strikes metal, will be reflected up towards the receiver loop. Having picked up the reflected wave it is necessary to amplify it, demodulate it and indicate somehow its strength, usually by means of a milliammeter in the output circuit or by observing the strength of the audio note in the headphones. In this instrument both methods

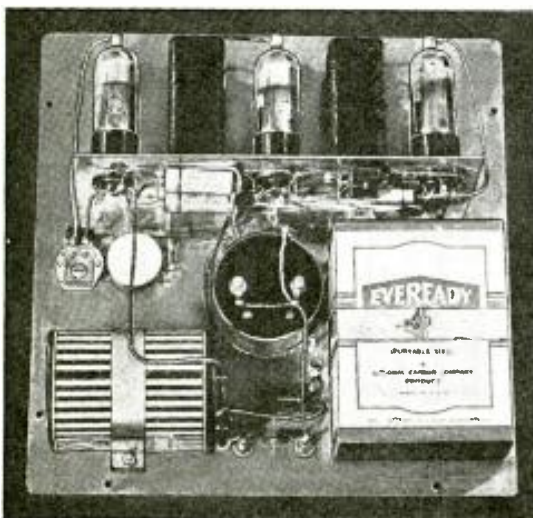

Interior view of the receiver, showing the neat efficient arrangement of all components and batteries.



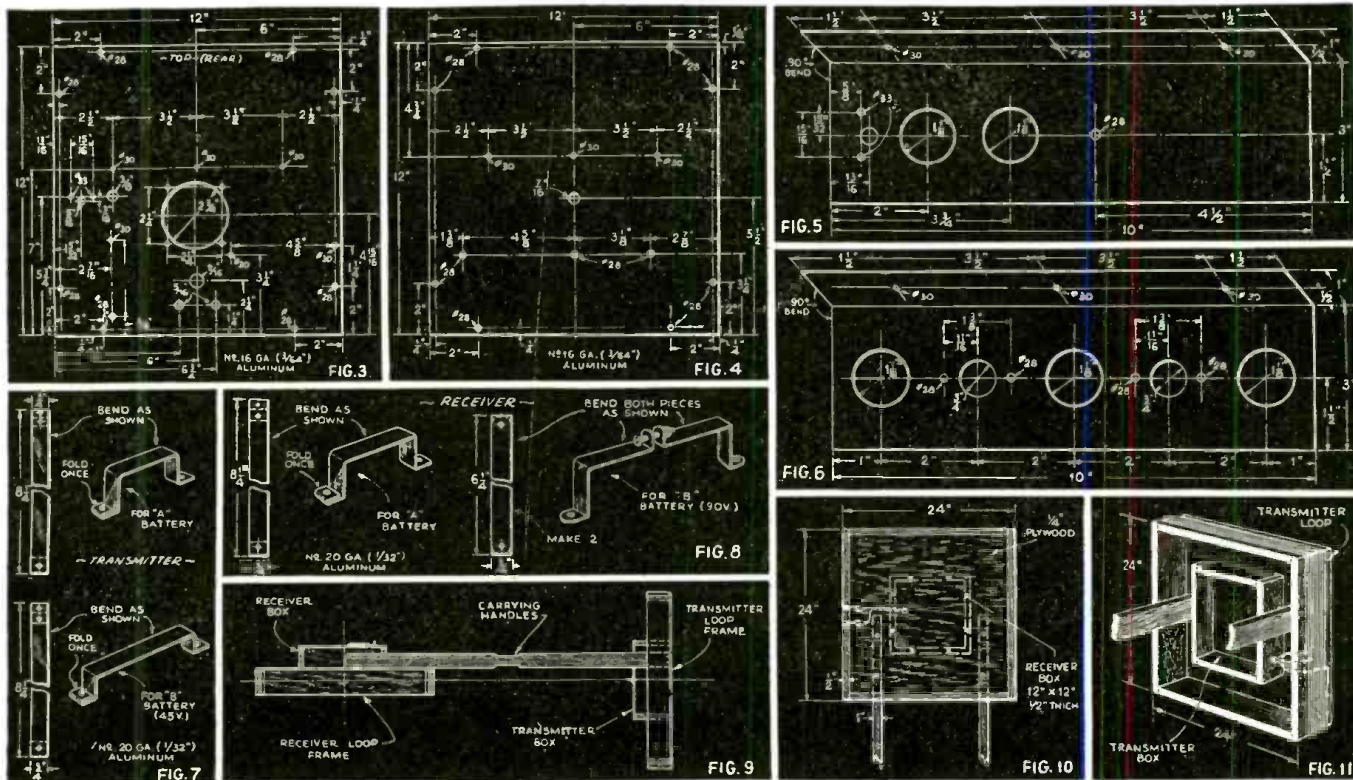

Detailed specifications of (Fig. 3) receiver panel; (Fig. 4) transmitter panel; (Fig. 5) transmitter subpanel; (Fig. 6) receiver subpanel; (Fig. 7) battery brackets for transmitter; (Fig. 8) battery brackets for receiver. Figure 9 shows both transmitter and receiver mounted in proper operating position on carrying frame; Fig. 10, details of receiver loop frame; Fig. 11, details of transmitter loop frame.

# RADIO TREASURE LOCATOR

*evinced in the past few years by our readers, that RADIO-CRAFT commissioned could be built entirely from standard parts and also be simple to operate.*

## STUART

are used to insure maximum accuracy.

The receiver and transmitter loops are mounted at exact right-angles to minimize direct pick-up, so that when walking over ground which contains no metal there will be very little, if any, sound in the headphones, while the meter will show a steady high value of current. The moment the radiated wave strikes metal, however, the sound will increase appreciably and the meter needle will dip backwards to a lower value and possibly vary a bit.

The high sensitivity and directional properties of this outfit were demonstrated in the writer's shop during the initial performance tests when a metal tool-box lying on the floor was "detected" at a distance of 10 feet. By turning broadside to the box, the sound faded to inaudibility. In field tests, undertaken to determine the maximum depth of penetration, pick-up varied from 10 to 17 feet depending upon the types of terrain.

## CONSTRUCTION

The actual construction offers no particular difficulty to any one handy with tools, however the following pointers should be observed.

First of all, use only aluminum for

the panels, see Figs. 3, 4, 5 and 6, and for the battery brackets, see Figs. 7 and 8.

Secondly, when wiring the "B" battery plug connectors be sure to cut off all three Fahnestock clips and solder the leads to the pins direct.

Third, do not rely on the aluminum panel as a common ground, instead run a single piece of hookup wire from one ground connection to another, finally grounding this lead to the chassis at one point only, that is at the ground side of the ON-OFF switch. This procedure applies to both receiver and transmitter.

Fourth, the transmitter loop has 24 turns of No. 24 magnet wire center-tapped at the 12th turn. The receiver loop has 24 turns of the same wire and no tap.

Fifth, the transmitter circuit must be tuned to oscillate at 175 kc. This is easily done by tuning any broadcast set to 700 kc. while the transmitter is "ON" and trimming the padder on the subpanel back

and forth until the oscillator tone is loudest in the set. Thereafter this adjustment need not be disturbed.

Sixth, when the receiver is completed, it too, must be aligned at 175 kc. For this job, turn on the transmitter and

*(Continued on page 182)*

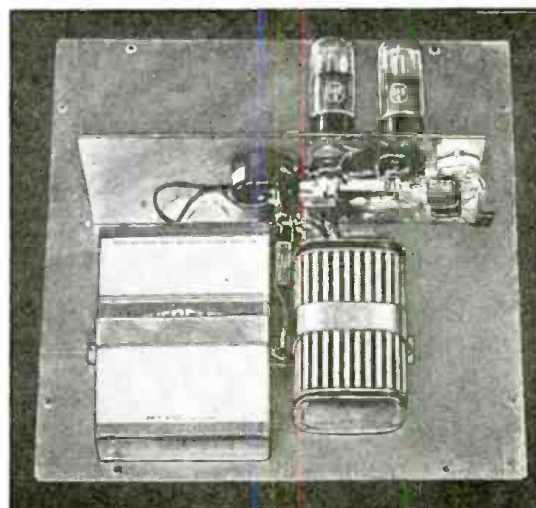

Interior view of the 2-tube signal transmitter. Only absolutely essential parts are incorporated.

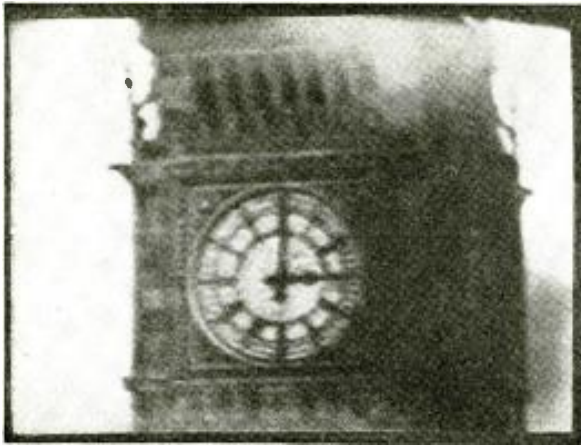

← Fig. 1. The distortion of the top part of this image is due to incorrect image-line synchronizing pulse application networks.

Fig. 2. This picture shows the effect of poor image-line synchronizing during the framing period. Note instability at top and bottom of image.



# SERVICING TELEVISION

*Unlike previously published articles of a theoretical nature articles, which we reprint by special permission of Television practical analysis illustrated with photographs of images*

S. WEST

**L**AST month we considered the requirements of synchronism for the horizontal circuits. In the case of synchronism for the vertical scanning circuits the effects are somewhat different, though the causes are the same.

With pulses of insufficient amplitude, the frame hold is insecure, the image will then travel upwards across the screen or may even assume the form shown in the photograph reproduced in the July article (Fig. 4). If the frame pulse has too great an amplitude or if this pulse is poorly filtered the image will tend to blink, or even assume permanently the form of the photograph also reproduced in the above (July) article (Fig. 5).

If there is a substantial hum content in the sync. pulse output and if there is an appreciable phase difference between the power-line supply of the receiving station and that of the transmitter, as is highly probable in districts remote from the transmitter, the image will tend to lock at some intermediate position on the screen, thereby providing 2 equivalent fractions of the image. It is of cardinal importance that there be no

A.C. ripple present in the sync. filter output. Attainment of correct interlace under such conditions is impossible, but this will be more fully dealt with when considering the subject of interlacing.

It is now necessary to deal with a fault peculiar to the line time base only.

## LINE TIME BASE FAULTS

Reference was made earlier to the half-line pulses maintained during the vertical synchronizing. It is to these we can attribute a very common trouble in television receivers. Namely, the tendency for the top part of the image to be horizontally displaced, the subject matter therein appearing to lean sideways (see Fig. 1). In some cases this horizontal displacement will not be maintained stably, the top edge of the image fluttering in an irritating manner.

This effect is a little difficult adequately to convey with photographs but careful study of Figs. 2 and 3 will give some idea of the effect. Note in Fig. 2 the "B.B.C." is fuzzy, showing that this portion of the image has moved during the exposure. The "Television Service" suffers in like manner though here the effect is not so marked. The lower-half

of the image has remained perfectly steady. Comparison with the same parts in Fig. 3 shows the latter to have remained steady throughout the exposure.

To appreciate the reason for this it should be remembered that, during the framing period, the character of the synchronizing pulses is altered, this change being necessitated by the requirements for vertical synchronizing. It is, of course, essential to maintain accurate line synchronism during the framing period for, otherwise, the line time base operates freely and must be brought into step during the vertical sweep, thus causing some top part of the image to be poorly synchronized.

This requirement is provided for in the transmitted signal. (See Fig. 4.) It is seen that the framing impulses are divided into half-line intervals; this incidentally is necessitated by the changed conditions prevailing during the odd and even frames in an interlaced system.

The steep front of these rectangular framing pulses is responsible for maintenance of line synchronism during the framing period and is applied through a high-pass resistance-capacity network to the blocking oscillator. This is only one of the many ways in which this function may be carried out, but it is the most popular. To deal with all the various arrangements possible is beyond the scope of the present series.

It will be obvious that, due to the presence of series capacity in the network, the D.C. level of the pulses will change. (See Fig. 4b.) A corresponding change in amplitude of the pulses will occur and line synchronism will be poor during the framing period. This is the explanation for this displacement of the top edge of the image. Whether the displacement is irregular, i.e., flutters, will depend on the design of the time

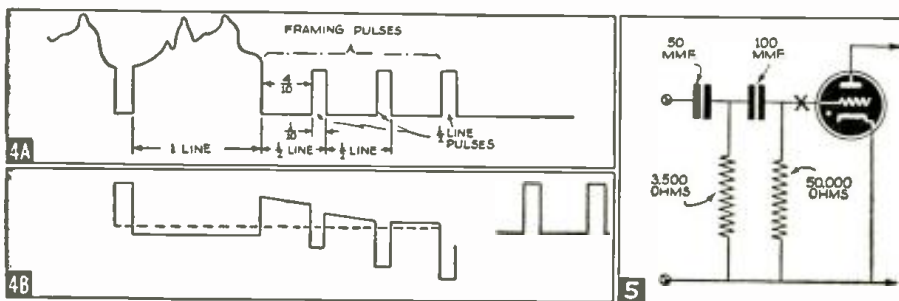

Fig. 4A. Showing the form of the frame synchronizing pulses. When applied through a low time constant network these assume the form shown in Fig. 4B. With a high constant, the level is substantially maintained, the shape being as shown at the right in Fig. 4B.

Fig. 5. A suitable application network for the line pulses. A 5,000-ohm resistor may be used at X to avoid feedback of impulses due to grid current.





← Fig. 3. In this picture the line synchronism is well maintained during the framing period as shown by steadiness of the upper and lower portions of the image.

Fig. 7. Actual photo of pattern resulting from an incorrect choice of I.F. or similar effects described in text.

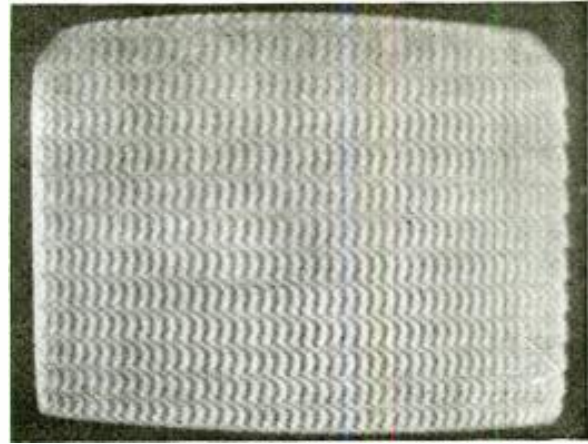

# RECEIVER FAULTS

on the servicing of television receivers this series of and Short-Wave World (London, England), is a which depict the actual faults being discussed.

## PART IV

base and the manner in which synchronism is applied.

Presence of this fault indicates a too low time constant and the value of the sync. application condenser should be reduced. A capacity of a few micromicrofarads will ensure that no D.C. change takes place, and will at the same time ensure adequate transfer of these steep-fronted pulses. A capacity of 5 to 20 micromicrofarads will be very satisfactory. A reduction in value for the grid leak also is helpful, for this reduces the time constant.

Care is necessary, however, in order that the tube maker's recommendations for the resistance in the grid circuit be adhered to. In this connection it is inadvisable to maintain this resistance with a high-value series leak, a slight elaboration of the conventional application network being more satisfactory. (See Fig. 5.) This arrangement, it is seen, retains a reasonable value of resistance in the grid circuit and at the same time permits a high time constant for the network.

This completes the description of faults likely to be encountered in the scanning circuits, and attention may now be directed to the image receiving circuits.

### RECEIVING-CIRCUIT FAULTS

Two main considerations apply here, namely, (1) the overall frequency response of the various circuits and (2) the rather stringent requirements from the point of view of phase shift at the upper and lower extreme frequencies. In addition, there are image distortions that can be attributed to "ringing" in the I.F. circuits or, where corrected vision-frequency stages are employed, to ringing in these circuits. This gives rise to effects that are illustrated and described later.

The term "ringing" embraces those conditions applying when a transient is not accurately reproduced, a damped oscillation occurring and distorting the applied transient voltage.

There are also faults due to the production of spurious beats which give rise to varying degrees of superimposed patterns in the image. In general these patterns can be attributed to an incorrect choice of intermediate frequency, harmonics of this I.F. frequency then occurring in the region of the signal frequency circuit's pass band. Care in the design of the detector filter will largely mitigate these effects, but in any case it is almost essential to choose an I.F. that is inherently immune from such troubles.

In certain cases where a separate sound receiver is employed having its own oscillatory circuits interference may be experienced from this source. This can result from a number of causes, but it is necessary only to switch off the sound receiver to ascertain if this is the case. In this event it will be found necessary to re-choose the intermediate frequency for the sound receiver having particular

(Continued on page 174)



▲ Fig. 10. This photo depicts the uneven image illumination resulting from inadequate low-frequency response.

▼ Fig. 11. Presence of hum in receiver output results in production of a dark horizontal band across the image.

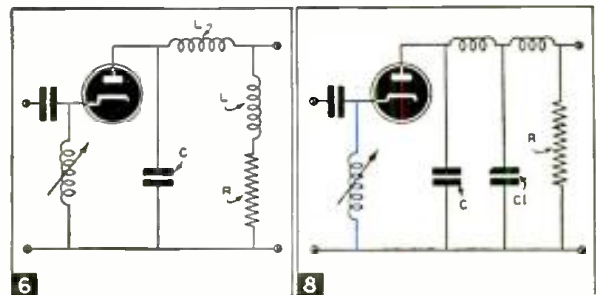

Fig. 6 (left). A generally-applicable detector filter. See text for constants.

Fig. 8 (right). An alternative form of detector filter. A series inductance is included to sustain the response at the upper modulation frequencies.

# SERVICING "Coin-Operated" PHONOGRAPHS

*Servicemen will find that, on 9 out of 10 calls, it's the sound system and not the mechanical system of coin-operated electric phonographs which requires servicing. There's business here for you.*

SANFORD MILLER

No. 4

**T**HE coin-phonograph Serviceman is frequently called upon to satisfy many unusual requests.

These come from the owners of various clubs, grills, halls, roadside inns and the many other users of coin-phonographs.

## SUITING THE CUSTOMER

A case in mind concerns a location owner who complained that the phonograph patrons turned the volume up too high, to the annoyance of others present. Removing the volume control key from the machine brought only temporary relief—the patrons had keys of their own!

Like most Seeburg models, this machine has a rheostat in shunt with the pickup to control volume. A separate 10,000-ohm rheostat was installed behind the bar and a shielded single-conductor cable was run to the pickup terminal strip. Thus the bartender could adjust the volume to a harmonious level without antagonizing the patrons. See Fig. 1A.

Another case involved a Wurlitzer model 412 owned outright by a restaurant and used to furnish dance music for private parties. The idea was for the machine to operate without coins and to have operation controlled from a remote point. A 150-watt lamp was installed in the socket provided in the 412 cabinet and connected in series with the magazine switch magnet, and a 2-conductor armored line was run to the pantry and terminated in a concealed, flush-type pushbutton. Thus, the instrument would play one record for every momentary contact on the pushbutton and would shut off automatically after each play or group of plays. This hookup enabled the owner to put from 1 to 20 plays on the machine as the occasion required. See Fig. 1B.

Now let's hear about some of the "tricky" service jobs that the writer has encountered. Maybe you Servicemen will be saved valuable time through knowledge of these puzzlers.

## OPERATING NOTES

**Seeburg Model Gem.** A loud howl was the complaint on a call that came in for immediate service. The offending machine was a Seeburg Model Gem and unfortunately the location was crowded with patrons, several of whom voiced their annoyance at having to listen to the nerve-racking din emanating from the loudspeaker, said din not being affected by turning the volume control off.

An ordinary voltage test was out of the question as the instrument could not be turned on for more than a few seconds without arousing the ire of everyone within earshot. A point-to-point resistance test disclosed that the amplifier was apparently OK. After opening the speaker voice coil circuit and placing a pair of headphones across the output, an 8 mf. condenser was tried in parallel with each filter and bypass condenser and the howl disappeared when it was tried from 1st 76 cathode to ground. Replacing the dual 12-mf. 25-V. cathode bypass condenser brought the sound back to normal. See Fig. 1C.

**Wurlitzer Model 24.** Quite a few Wurlitzer Model 24's have turned up lately with fading complaints, examination

showing the same trouble in each case. The quick-heater relay would deliver the normal 9.75 volts during the warmup period but as soon as it clicked the heater voltage dropped to zero. This is caused by no contact between the relay armature and the 6.3V. winding causing the heater voltage to see-saw between 9.75 volts and zero each time the relay clicked, causing fading. Carefully cleaning and re-adjusting the relay points is the remedy. See Fig. 1D.

**Seeburg Model Rex.** A complaint of intermittent sound was encountered on a Seeburg Model Rex. Examination showed everything apparently OK, but the location owner insisted the machine would suddenly go dead for a few seconds, and then snap on again. This sounded suspiciously like voice coil trouble so an 8-inch P.M. speaker was hooked across the voice coil leads of the 15-inch speaker and the instrument turned on. Sure enough, working the cone back and forth with both hands while the speaker was operating caused the main speaker to cut out each time the cone was pushed forward. The extension speaker meanwhile played normal. Since no replacement cone was available a 15-inch Wurlitzer speaker was dragged out of the car and the field coil was taken out and the tapped Seeburg field was mounted in its place. (A loose fit but it worked fine.) This temporary substitution enabled the instrument to operate until a new cone could be obtained.

**Wurlitzer 616.** An unusual case of fading was encountered on a Wurlitzer 616. This machine would play half-way through a record and then gradually die out. It was noticed that the 45 driver tube was not lit and although a new tube was substituted it still went out as soon as the tubes were thoroughly warmed up. This was caused by the filament contacts on the socket. Spreading and tightening these contacts afforded only temporary improvement. For a permanent repair all the 45-tube sockets should be replaced.

**Wurlitzer Model 24.** A model 24 Wurlitzer was the culprit on a "no sound" call. Examination showed no plate voltages on any of the tubes and the heater voltage was 9.8 volts, indicating an open in the power supply as the quick-heat relay would not click over. This was caused by an open-circuit between the high-voltage center-tap and ground, and was traced to a resin joint in the link between the No. 2 and No. 3 prongs on the speaker plug. This link protects the filter condensers in case the speaker plug is pulled out. See Fig. 1E.

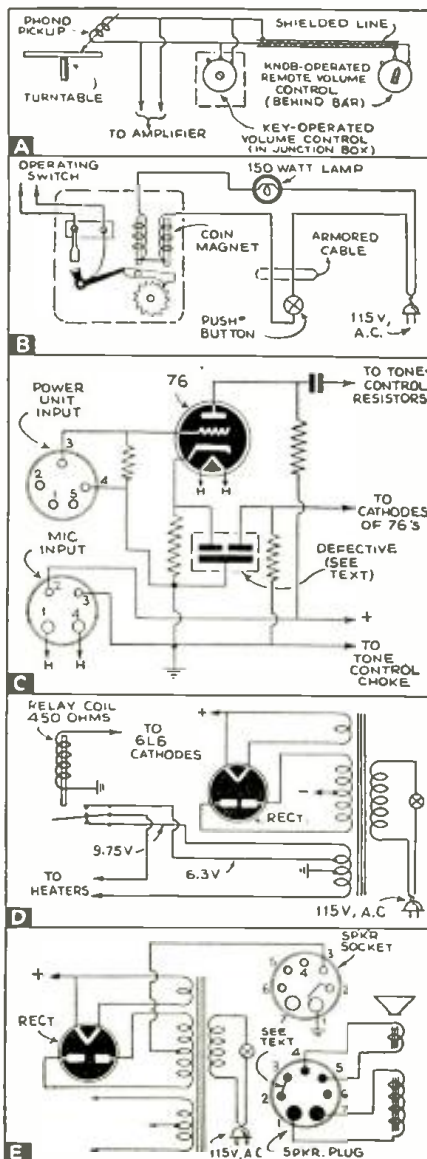

Fig. 1



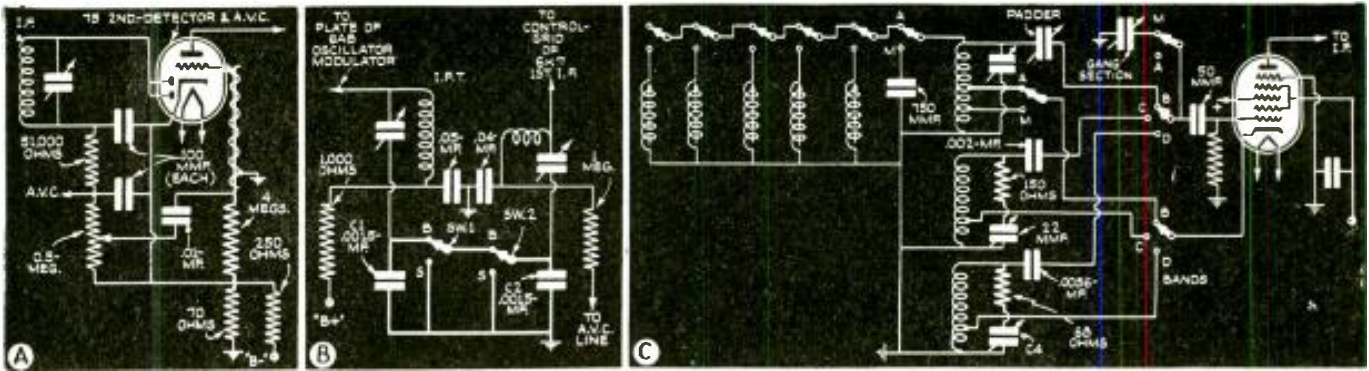

Fig. 1. New circuit features of (A) Philco Models 39-117, 39-118, 39-119; (B) Stromberg-Carlson Models 340 and 341; (C) General Electric Models H-73, H-77, H-78, H-79.

# NEW CIRCUITS IN MODERN RADIO RECEIVERS



*The details of the modern radio receiver circuits that make them "different" from previous designs are illustrated and described each month by a well-known technician.*

F. L. SPRAYBERRY NUMBER 24

### (1) SIMPLIFIED GRID SHIELDING

Philco Models 39-117, 39-118 and 39-119. To avoid the excessive capacity of a metal-shielded wire and the lack of flexibility of such a lead for a top cap grid connection, the insulated grid lead is simply wrapped with insulated wire.

The arrangement is illustrated in Fig. 1A. The grid and ground wires are simply twisted together very much as filament or heater leads are twisted in many receivers and the shielding which results is adequate for the purpose. The grid resistance is so high and the signal is so low at this point that shielding is essential.

### (2) SPECIAL SWITCH USED TO OBTAIN PRECISE PUSHBUTTON SETTINGS

Stromberg-Carlson Models 340 and 341. A switch is used for greatly reducing the I.F. coupling to the 1st I.F. stage so that the selectivity of the set will be greatly sharpened and setting of the pushbutton condensers can be made very accurately.

In the 1st I.F. transformer of these receivers the coupling is accomplished by means of a connection between 2 condensers in series with the tuned circuits.

These are C1 and C2 in Fig. 1B. The I.F. drop across C1 in the plate tuned section is impressed directly across C2 which supplies the grid circuit with the I.F. signal. The ganged switches Sw.1 and Sw.2, both on contacts B, provide the connection between C1 and C2 by which the plate and grid circuits are coupled. There is substantially no magnetic coupling between the plate and grid coils. When it is desired to set up the pushbutton condensers for automatic tuning in the detector and oscillator circuits, these switches are turned to contacts S for sharp selectivity. This opens the coupling connection from C1 and shorts out condenser C2. The reactances of C1 and C2 are comparatively so small that there is caused negligible detuning.

There is enough stray coupling within the I.F. transformer case to carry the signal through the circuit for the purpose of adjusting the automatic tuning condensers. The switches are then turned back to position B for reception.

Unless the precise pushbutton adjustments made by the Serviceman are automatically maintained the tone quality suffers.

### (3) IMPROVED OSCILLATION FOR INDUCTANCE PUSHBUTTON TUNING

General Electric Models, H-73, H-77, H-78 and H-79. To make sure of the desirable electron-coupled type of oscillator and to avoid an additional set of pushbutton contacts for the oscillator cathode tap for each station, a different feedback tap is chosen on the regular oscillator coil.

A cathode tap A for automatic tuning is shown in Fig. 1C. It is nearer the center of the coil than the tap M for manual tuning. For automatic or pushbutton tuning the 1st-detector or signal input circuit uses pre-set trimmer condensers, while the oscillator uses substitute pre-adjusted coils of the metal-core type. These latter are shunted across the regular coil having the taps. The inductive reactance from grid to ground is somewhat reduced and the voltage drop across every section of the inductance is reduced. To be assured of oscillation when the substitute shunt coils are used, a point nearer the center of the coil is chosen for the cathode tap so that the cathode induced voltage will be high enough to assure maintenance.

*(Continued on page 173)*

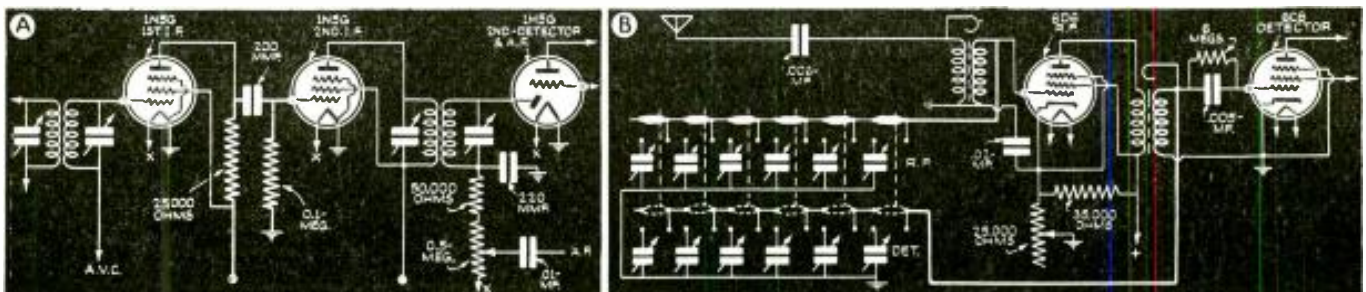

Fig. 2. New circuit features of (A) Emerson Model CT-275; (B) Sears Roebuck Model 7219.



## SORRY—NO MISTAKE

Dear Editor:

In your April edition you publish a 4-Tube Amplifier by Kendall Ford using 1—5Z3, 1—6A6, and 2—6B5 tubes. I built this amplifier but I am afraid there is some mistake as I cannot get any gain for mike. I have tried different ways but without results. It is stated that he uses 0.5-meg. resistor from grid of 6A6, which I think is wrong and should be 5 megohms.

Would you be so good and please send me further details on same. For phonograph there's more than is wanted, and seeing as I have built it I should very much like to get this right.

(1) Voltages; (2) load on output transformer, plate-to-plate; and (3), resistance of choke used.

A. H. PALMER,  
Cape Town, South Africa.

(This letter was referred to author Ford, whose reply follows:)

Dear Mr. Palmer:

Your letter relative to the 4-tube amplifier which was described in the April, 1939, issue of *Radio-Craft* has been forwarded to me.

If the amplifier is constructed exactly as directed you should have more than enough gain for either a crystal or velocity microphone. The actual gain is over 100 db. I should like to suggest that you check your wiring over carefully—perhaps there is a slight error that you may have overlooked.

The input resistance of 0.5-megohm is correct but if you care to experiment with other values it is an easy matter to make the change.

The plate-to-plate load resistance is approximately 10,000 ohms. The input choke is a regular class B choke with a maximum D.C. rating of 175 MA. The speaker field which is used as a filter choke has a resistance of 1,500 ohms.

My own amplifier from which the article was written is functioning perfectly as are a number of those of my friends who have built similar amplifiers, so I feel certain that yours will do likewise if it is built exactly according to instructions.

KENDALL FORD,  
Los Angeles, Calif.

## NEW SOUND TRUCK

Dear Editor:

We are enclosing a picture of what we feel to be the finest traveling demonstrator in the country today.

Our company has always been ahead of all the other companies, which can be proven by a story and picture that appeared in

*Radio-Craft*, July issue, 1936, in which we had the distinction of being the first traveling sales and service on wheels. We have carried this idea through the years and now step into another field. The following story describes it:

In the July issue, 1936, of *Radio-Craft*, a story of the first traveling Sales and Service Truck appeared, which was operated by the writer. Since then, a great many companies have copied after this.

After the first of the year the writer turned the Fuller Specialty Company over to his wife to operate and entered into the Factory Representative field.

Having first started the delivering of merchandise to dealers as a distributor and seeing how effective it has been, the writer is going to endeavor to operate similarly, but sell only distributors. Also this truck will be used as a demonstrator to help the distributor promote Sound.



The truck is equipped with 4 University speakers and units, powered by a complete electric light plant, in the rear, which is remote-controlled from the front. At the present time, the amplifier is a rebuilt job. The panel inside of the truck contains an A.C. voltmeter, a 3-input electronic mixer, and a matching arrangement on the speakers. In the rear are shelves to carry samples and equipment to give a complete demonstration to the distributors or to their dealers.

As we have said before, we feel this is somewhat revolutionizing the field, but think that eventually all Factory Representatives will have to come to this mode of traveling.

W. L. FULLER, JR.,  
Parkersburg, W. Va.

## KNOCKS "PROGRESS" IN RADIO

Dear Editor:

Your editorial in the July 1939, issue of *Radio-Craft*, strikes me as partly wrong.

The last two years have not brought forth as much progress as it seems. The large numbers of new tubes, for instance, are not all good improvements. The rapid change of base types in tubes, and the different, and in some cases, outrageous, filament voltages, just making it easier and cheaper to build punk sets, are unnecessary to say the least. Too many of these tubes have almost the same characteristics electrically. All this adds up to a great burden for the average Serviceman. It causes him to have to carry an enormous stock of tubes to have a complete line. Several of the leading sets have gone back to the old 6A7, 78, 75, 42, and 80 combination for their small sets. Some of the best communications receivers on the market still use the old 2.5-volt tubes. Ask any Serviceman how many tubes he ever found that had fallen out of a socket. The loctal-base tube was rather a useless addition.

There has been some real good done in bringing out the new 1.5-volt tubes and the special tubes for high frequencies. But for regular B.C. receivers, we could get along just as well with the tubes we had in 1935-'36.

As for built-in antennas, we had loop antennas in 1925, and I have yet to see the noise-free antenna you speak of. The average A.C.-D.C. set of the last two years is abominable. They are a disgrace to anything you could possibly call "progress." The manufacturer, the distributor, the dealer, nor the Serviceman can ever hope to make anything on sets that sell below \$20. Would you be interested in putting \$3 worth of tubes in a set that retailed for \$6.95? Many of these sets do sell for that.

The designers and engineers who are responsible for the new sets have forgotten what an R.F. stage is. We have \$150 sets that boast no R.F., just to make it easier to put in pushbutton tuning. In addition to having no R.F. stage, they also leave off the proper shielding, and these two things bring lots of interference from undesired stations. As for quality, any of the old 10- and 12-inch dynamics of 1930, sound much better than the modern midget speakers of 2 to 6 inches.

Radio has assuredly progressed in most fields, but for the last two years, the B.C. radio industry has retrogressed as a whole. Let's hope that this year, the industry will get together and quit the foolishness of the past and give us some real progress.

ARTHUR H. LOE,  
Jonesboro, Louisiana

## CONSTRUCTION "BUGS"

Dear Editor:

In regard to the V.-T. Voltmeter described in October *Radio-Craft*, 1938, I have a problem.

In making this V.-T. voltmeter, have used Weston wire-wound shunts and a Jewell 0-1 ma. meter.

Unit will calibrate and adjust to zero. When I attempt to measure 1 volt D.C., the meter flies way off scale. I have tried the 10-volt position and then it reads 2 volts for any voltage; it will act the same on the A.C. position.

Have you any suggestion?

JOE TALLMAN,  
Amsterdam, N. Y.

(This letter was referred to the author, whose reply follows:)

Dear Mr. Tallman:

I am sorry that I cannot give you any definite help on the V.-T. voltmeter. It would seem that you have made an error in the switching and in connections of high-value

(Continued on page 170)



# SERVICING

## Questions & Answers

### DISTORTION AT HIGH VOLUME

(136) Roy Winterton, Paw Paw, Ill.

(Q.) I have an Atwater Kent radio model 70, serial number A-103772 in my shop that is giving me a great deal of trouble with distortion at high volume. When set is set at low volume it sounds OK.

Set suddenly went dead and found resistor nearest to back of set in power and audio section open, so replaced with new resistor after which set worked the way it does now.

I have tried different values with no better success. These resistors are color coded, but this color code is not standard. Condensers and tubes test OK.

Please write and let me know what may be causing this trouble; and see what you can do about sending some information on the resistors in this set so I may check them.

(A.) In the Atwater Kent model 70 receiver, the complaint of distortion is usually attributed to 2 faulty resistors. These units, one coded white and the other black, 40,000 and 65,000 ohms respectively, either open-circuit or change value. These resistors are located directly in front of one of the type-45-tube sockets, below chassis. We suggest replacement.

### SPEAKER TRANSFORMER PUZZLE

(137) L. E. Chann, Pace Radio Service, Pace, Miss.

(Q.) Perhaps you can clear a rather baffling problem I have encountered in the Detrola model 145 and similar circuits under other names. I know Air Castle has one exactly like it.

A Detrola 145 was brought in the shop with the complaint: "low volume and fading, and occasionally not starting even though the battery is up and everything lit up normally." The fading was caused by a defective A.V.C. circuit. The hard starting was due to a weak 6D8G oscillator. (Checking for reasons for the low volume, I found one side of the primary of the output transformer nearly open. It had a D.C. resistance of about 200,000 ohms. Replaced with one with correct impedance for push-pull 33's which this circuit uses for output. No perceptible increase in volume. Gave the set complete realignment from antenna to 2nd-detector. No results.

Next I checked all tubes. All OK. All socket voltages OK. Vibrator OK. Filter units, and all power supply units OK. No shorted or open condensers. (Replaced these one by one to check.) All resistors were checked and found to conform to schematic. No opens or shorts or abnormally high resistance in coils. Input to output stage was good and had plenty of excitation. Finally, after eliminating everything, I suspected the speaker. A P.M. dynamic is used in this model. Thought perhaps the magnet was weak. Bought another speaker. Still no improvement. No noticeable distortion with this low volume.

About this time an "Air Castle" was brought in the shop. Being completely puzzled with the Detrola I left it and repaired the Air Castle. While doing so I noticed the identical circuits. Checking the two together, I found the only difference to be in the ohmic resistance from the type-33's plates to center-tap of the output transformer primary. Since this transformer is mounted

(Continued on page 185)

## SUCCESSFUL SERVICING

James F. Waldron's radio service shop in Norwood, Mass. It goes under the name of Community Radio Laboratory. Test instruments he uses are all Clough-Brengle jobs as follows: a model CRA oscilloscope on a tilt-turn tripod, a No. 110 signal generator, No. 111 uni-signal frequency modulator, No. 135 uni-checker, and a No. 79C beat-frequency oscillator. Mr. Waldron does considerable business for auto-radio dealers who do not maintain radio service departments of their own. His method of doing business, as told in the story below, is quite successful and is recommended to other independent Servicemen.



**S**UCCESSFUL servicing from the shop owner as well as customer standpoint is exemplified in the solidly established and increasingly prosperous business of Community Radio Laboratory, Norwood, Mass., operated by James F. Waldron.

Expert service, expertly advertised, keeps this shop filled with work the year round, at profitable rates of pay, and this without making any calls whatsoever in homes, either for the purpose of giving estimates or performing service work.

Rate of fee is \$3, minimum or per hour. Some estimates are given free and others not, depending on conditions. For example, if upon examination it is found that the trouble will take some time to isolate, and in some cases, even require repairs before an honest estimate can be given, a charge

of \$2.50 is made, which is deducted from the service charge if the owner decides to have the work done.

In addition to its principal business of home receiver servicing, Community Radio Laboratory installs and maintains police communication apparatus, builds and sells sound equipment, noise elimination filters, electronic control devices for retail store advertising, and in fact anything for which there is a profitable sale.

An increasing phase of the company's activity is work done for auto-radio dealers who do not maintain a radio service department of their own. Work for such dealers requiring less than an hour is performed at a flat rate of \$1.50 per unit, while jobs requiring more than an hour are billed at

(Continued on page 184)

## OPERATING NOTES

### Trouble with . . .

#### . . . MAJESTIC MODEL 15

Receiver "dead." caused by burned-out antenna coil. In replacing with new antenna coil, use an antenna-coupling condenser, and check power supply primary buffer condenser (0.01-mf.) for short, or open, replacing same with one of higher voltage rating.

#### . . . PHILCO 800 AUTO RADIO

Receiver inoperative. Cause, vibrator point sticking. Replace with new unit, Part No. 38-50-55. Do not attempt to file vibrator points. In replacing, check huffer condenser for an open or short. In order to test same it will be necessary to unsolder one lead in the primary circuit of power transformer. Open or shorted buffer condenser causes continued arcing at points of vibrator.

Receiver also out of adjustment due to improper alignment of oscillator circuit. Realign the I.F. amplifier, and then adjust both the high- and low-frequency padders. Adjustment at 1500 kc. and 600 kc.

#### . . . RCA VICTOR COMBINATION RE-40

Weak pickup due to partly-demagnetized pickup unit. This can be determined by picking the needle on the pickup unit with your fingernail and listening for a series of clicks. If sound is weak, remove the cover of the pickup, and test for pull of the magnet. If weak, it will be necessary to remagnetize. In replacing magnet keep same clean of any dust or dirt and be sure to correctly center the armature. This can be determined by feeling the play in the armature with the needle inserted.

GEO. F. BAPTISTE.

#### . . . AIRLINE MODEL 62-451

Symptom: noisy reception, and 6G5 tuning indicator would not work at all. It was found that the shielded lead from the condenser gang was touching the aluminum shield on the underside of the chassis. Upon separating these the set worked normally. Also electric tuning did not work at all times. Pressing the contacts of switch more closely together solved this problem.

V. DALE HAAS.

#### . . . ALL DELCO VIBRATORS

When vibrator fails on Delco sets look inside can for insulation worn off leads. I have found that trouble in Delco vibrators is caused by grounded leads in about 75% of the cases.

J. M. MCKIE.

#### . . . PHILCO MODELS 620, 625, 630, 635

If set is dead or has very low volume and distorted tone, test the 0.09-mf. 2nd-detector plate condenser, which bypasses the 99,000-ohm resistor, for shorts or open. This is a haketite condenser, Philco part No. 4989-SG. We have found that this is the usual defective spot in these models, but have not had any trouble after replacing with the new, improved Philco part No. 4989-OSG.

#### . . . PHILCO MODELS 38, 38A

Weak reception and low volume in this model is usually due to trouble in the battery switch, the contacts of which become weak and consequently make poor contact. The new Philco replacement switch for these models is much improved and we have not had any complaints after using them.

(Continued on page 167)



Front view of the neutralized-feedback amplifier. Its various controls, from left to right, are: Microphone No. 1 Volume; Microphone No. 2 Volume; Phono Volume; Auxiliary Input Volume; Low-Frequency Tone Control; High-Frequency Tone Control.

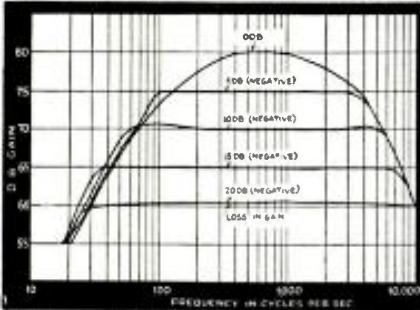

Fig. 1. Curves showing loss of gain, and frequency correction with varying amounts of negative feedback.

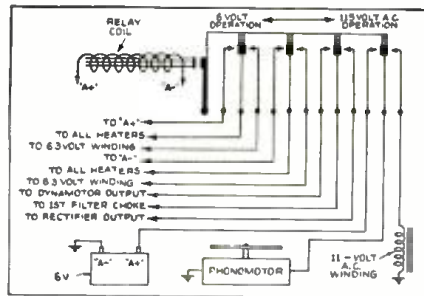

Fig. 3. Relay switch for automatic change-over from 6 V. to 110 V. A.C.

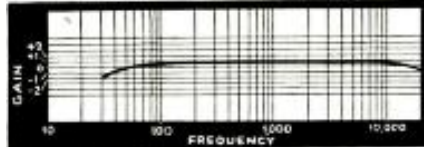

Fig. 2A. Overall response with positive and negative feedback.

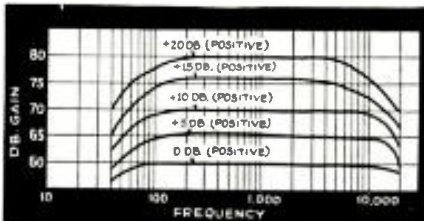

Fig. 2. Showing increase of gain and response change with varying amounts of positive feedback.

automatically selects the 6-volt mode of operation. No damage can result, regardless of how this unit is connected to either one or both of its operating sources of power.

*Economical operation* is obtained by the use of a conventional stand-by switch, plus a class B output stage.

#### THEORY OF NEUTRALIZED FEEDBACK

The use of Negative Feedback has become so popular during the past few years, that few realize the actual sacrifices made in the average amplifiers to obtain some pre-determined performance characteristic. The proper application of negative feedback will tend to reduce hum, amplitude distortion, frequency distortion and tube noises generated within the feedback loop. For this corrective measure, gain must be sacrificed, the amount depending upon the design of the amplifier.

The average feedback circuits provide a loss of gain ranging from 3 to 20 db. While this loss is not of vital importance in A.C.-operated amplifiers utilizing high-gain driver and output stages, it assumes major importance when applied to class B circuits, and for this reason, its application to class B circuits has been limited.

## UNIVERSAL 32-W. *Neutralized-*

*The author believes that the high-power amplifier described in this article in-*  
 (1) a method for applying regeneration as a means of compensating the loss  
 and, (2) a robot change-over device which automatically permits operation

A. C.

ONE of the most interesting amplifier problems which faces the modern sound engineer is the design of an efficient, fool-proof, light weight, high-power, and economical high-fidelity universal amplifier for operation from either a storage battery or from both a storage battery and commercial power lines.

The amplifier described in this article utilizes a number of features never before combined into one compact unit. These features include:

- (1) Neutralized Feedback
- (2) High Efficiency
- (3) Fool-proof Operation
- (4) Degenerative Cathode Drive
- (5) Switchless Change-over from 6 volts D.C. to 115 volts A.C. or vice versa

The inclusion of these features makes the amplifier admirably suited for all types of portable, mobile, or semi-permanent types of installations wherein quality of reproduction, plus efficiency of operation are prime requisites.

#### HOW THESE VALUABLE FEATURES ARE OBTAINED

*High efficiency* is obtained by careful selection of class B output tubes plus a coordinated cathode type of driver and

well-regulated power supply.

*Flat response* is maintained by the generous use of a negative feedback to compensate for variations in frequency response of the driver stage, and output transformer.

*High-gain* is obtained by utilizing the latest type of preamplifier, voltage amplifier, and driver tubes, plus a system of "positive feedback" (regeneration) to compensate for loss of gain in the "negative feedback" (degeneration) circuits.

*Fool-proof operation* is maintained by including a 6-volt relay, which automatically switches 3 essential circuits from their conventional 115-volt A.C. power supply to an efficient built-in dynamotor. This change-over is made without the use of any external plugs, cables, or additional switches. It is automatically made the moment the storage battery cable is attached to its storage battery. If, for any reason both the 115-volt A.C. supply and the 6-volt storage battery leads are simultaneously connected to their respective sources of power, the relay

(Please continue to TOP, next column)

The form of frequency distortion correction networks used in conventional negative-feedback circuits provide for corrections in frequency response in accordance with the illustrations of Fig. 1. It can readily be seen that the greater the amount of frequency correction desired, the more negative feedback will be required, and the lower the overall gain of the amplifier. Naturally, this feedback not only corrects for frequency distortion, but also cancels an appreciable part of tube noises, hum, and grid-circuit distortion generated within the loop.

When a feedback circuit is used only to correct for frequency distortion, then the amount of feedback

must, of necessity change with frequency. This type of a circuit, however, can not be depended upon to maintain a fixed correction for hum, grid circuit distortion, plate current distortion and tube noises. If a type of feedback is employed which not only corrects for frequency distortion, but tends to improve power output and minimize hum and other objectionable features, an appreciable loss of overall gain must, of





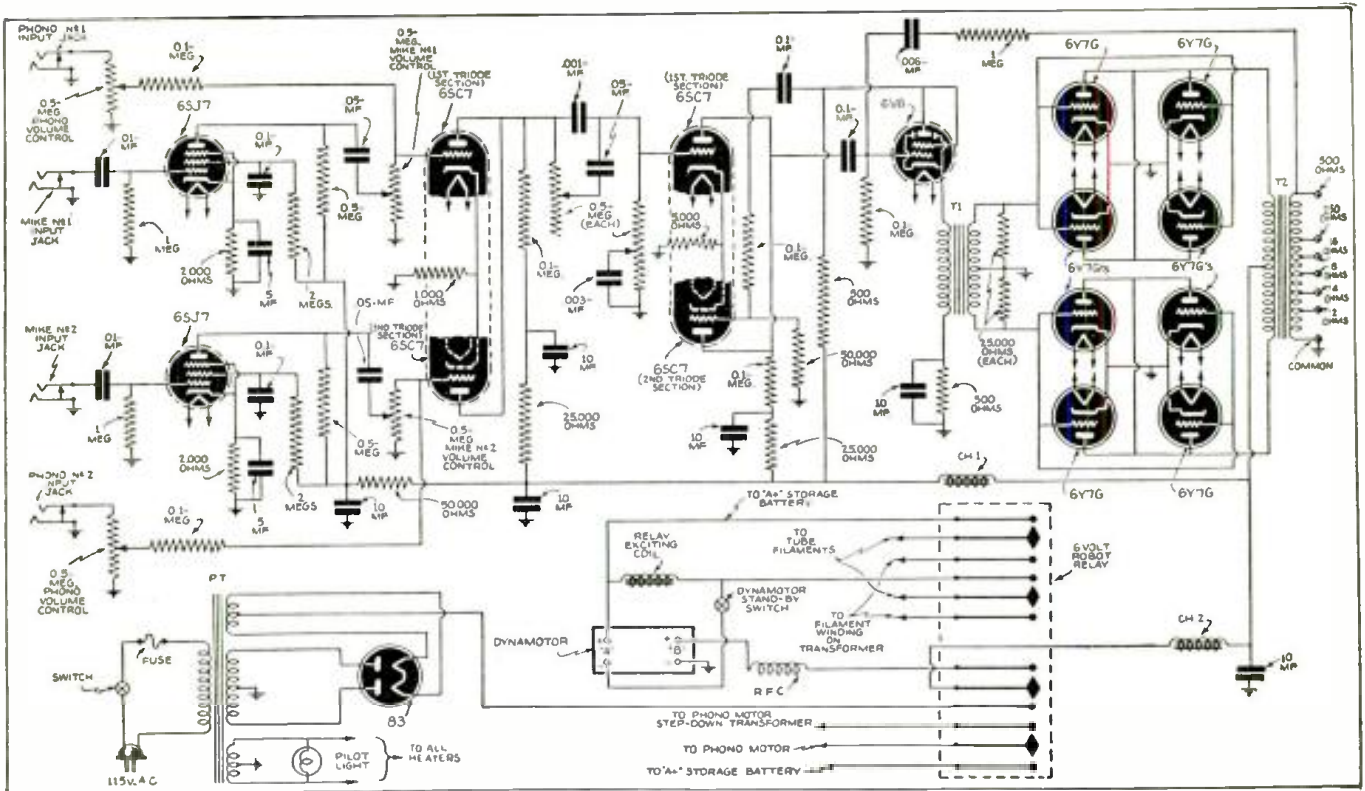

Complete schematic diagram of the 32-W. neutralized-feedback P.A. amplifier for both 6-V. D.C. and 110-V. A.C. operation.

# Feedback P. A. AMPLIFIER

cludes features never before combined into one unit. Among these features are in amplification which ordinarily results when negative feedback is employed; from either a 6-V. storage battery or a 115-V. A. C. power line.

## SHANEY

necessity result. To compensate for this loss of gain, Positive Feedback or regeneration can be employed.

Figure 2 shows the effect on response of regenerative feedback. It can easily be seen that regenerative feedback must be applied across a portion of the circuit which has a practical flat-response. Otherwise, any existing deficiencies will be exaggerated. It becomes a relatively simple matter to design a single stage with minimum hum, frequency distortion, and tube noises. If this is done, as much as 10 db. can easily be applied without introducing any undesirable effects. The trick of this application, however, is to apply the negative feedback to the comparatively poorer portions of the circuit, and positive feedback to the higher-fidelity sections of the amplifier.

The application of neutralized feedback lends itself admirably to mathematical treatment. In the interest of brevity, however, this will not be entered into unless sufficient interest for a more detailed explanation exists among *Radio-Craft* readers.

### 6Y7G's FOR HIGH EFFICIENCY

Although the 6L6 has justifiably received a considerable amount of favor-

able comment from design engineers, from an efficiency viewpoint however, a number of conflicting factors enter into the selection of such a tube for use in an automobile amplifier. Most calculations involving the efficiency of power output tubes usually disregard the filament consumption. This factor, however, becomes of vital importance in the design of a 6-volt or universal amplifier because heater current may assume appreciable proportions and disturb conventional efficiency ratings.

There is no doubt that class B tubes are most efficient for audio work, particularly wherein current drain is a primary consideration. A careful analysis, and efficiency calculation of all existing available tubes, will rapidly disclose the advantages of using the 79 (which is a prototype of the 6Y7G) for an efficient power output stage.

The following tabulation clearly indicates how an average of 3.2 amperes can be saved for each hour that a 32-watt amplifier is operated. For purposes of tabulation, published ratings have been used. Two 6L6's operating in a 32-watt condition are compared with four 6Y7G's (see schematic diagram, above) operating in a 32-watt condition (8 watts each).

WATTS DISSIPATED					
	6L6	6L6	6Y7G	6Y7G	
	Max. Signal	No Signal	Max. Signal	No Signal	Efficiency
6L6	11.34	54.2	3.75	69.29	$\frac{32}{69.29} = 46\%$
6Y7G	15.12	41	—	56.12	$\frac{32}{56.12} = 57\%$
	15.12	20.1	—	35.22	—

To calculate the amount of amperes saved, simply add the no-signal and full-signal total watts dissipation of each of the tubes, and divide by 2. Average Dissipation of two 6L6's—64.98 watts. Average Dissipation of four 6Y7G's—45.67 watts. The saving of 19.31 watts represents the difference of the above averages. If this saving is divided by 6 (volts), 3.2 amperes is the amount of current saved for each hour of operation of the amplifier.

### THE SWITCHLESS SWITCH-OVER—AND OTHER FEATURES

Figure 3 illustrates the simplicity of the automatic change-over relay switch. It will be noted that only the heaters (Continued on page 167)

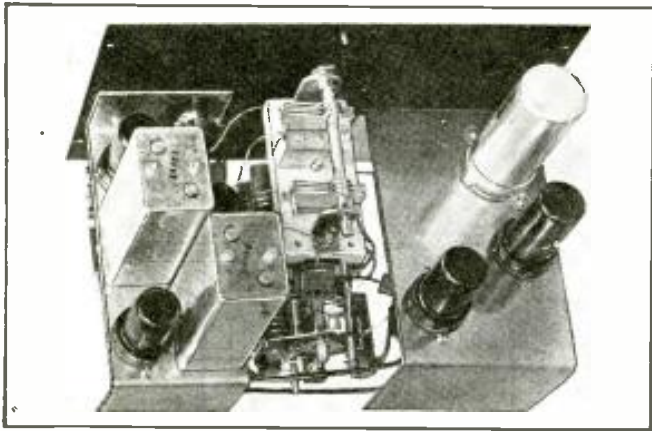

Rear view of the completed Hi-Fi U.-S.W. Adapter. Its tuning range is from 62 megacycles to 20 megacycles in 5 bands.

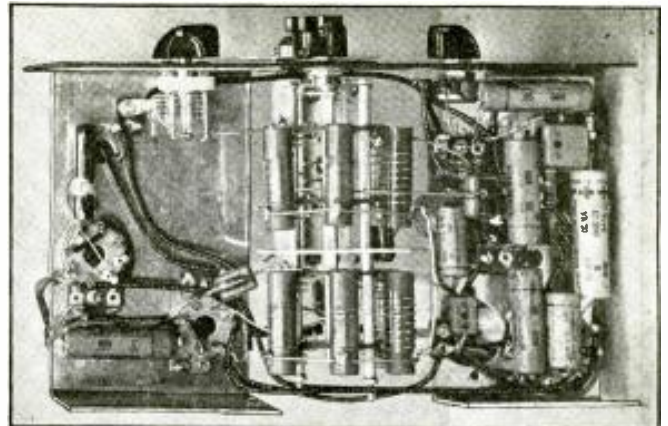

Under-chassis view. Five coils are employed for both oscillator and tuned-antenna circuits.

## BUILD THIS 5- TO 20-METER

*Messrs. Browning and Gaffney have done a swell job on a 5-tube Hi-Fi Ultra-use in the tuning range of 62 to 20 mc. Unlike hi-fi converters, the outputs of the associated receiver, this adapter for the first time makes it possible to feed*

**GLENN H. BROWNING and**

**P**ROBABLY all of the readers of this article, at one time or another, have wanted to listen-in on the sound channel of television stations, the special high-fidelity broadcast stations, the new ultra-shortwave school stations, 2-way police telephone conversations, etc., on frequencies beyond the range of their present receivers. This is made possible by the Hi-Fi Ultra-Shortwave Superhet. Adapter to be described.

The adapter utilizes 4 of the new metal single-ended tubes. (Refer to schematic diagram, Fig. 1.) A 6SA7 is used for a mixer, a 6SK7 used for the I.F. amplifier stage, and a 6SQ7 used as a 2nd-detector and 1st stage audio. It was found advisable to eliminate locking-in effects by the use of a 6SK7 as a separate electron-coupled oscillator. From the standpoint of convenience, an A.C.-D.C. power supply system is employed consisting of a 25Z6 as a rectifier and a resistance-capacity filtering circuit. To cover the range of frequencies from 5 to 15 meters, it is necessary, of course, to employ more than one coil and, for convenience, band switching is employed.

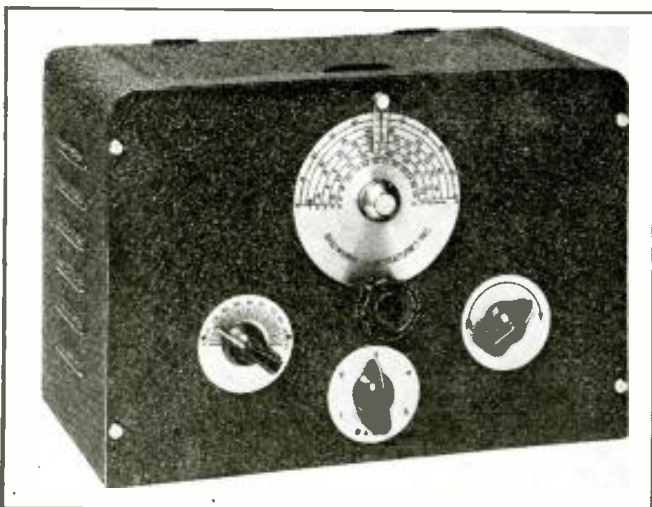

The Hi-Fi Adapter in its handsome cabinet ready for operation.

### CIRCUIT FEATURES

As the tuning on the higher frequencies is quite critical, it was decided to employ 5 coils for the oscillator and the tuned antenna system. These are rigidly mounted on a 5-position 4-section switch with a metallic shield interpositioned between the oscillator and antenna coils. With 5 coils, the effect of band-spreading the various ranges may be accomplished by using a small-capacity variable air condenser which, in the converter described, was 30 mmf. per section (a 2-section gang being used).

On the higher frequencies, the input resistance of the mixer tube begins to give a noticeable loading effect on the tuned antenna system, materially reducing the Q of this system and thus the gain in the tuned antenna stage. To eliminate this loading effect, controllable regeneration was used. This was obtained by tapping the antenna coils and connecting this tap through a resistor and bypass condenser to the cathode of the 6SA7 tube. Varying the screen-grid voltage of this tube controls regeneration. To allow for the various antenna capacities, a separate 20 mmf. condenser control from the front panel is placed across the antenna tuning system.

An intermediate frequency of 1,600 kc. was chosen for several reasons. It is low enough to make possible an I.F. amplifier whose adjustment is not especially critical. Its frequency is outside the broadcast band and is used commercially only by police and certain aviation services. Little, if any, interference will therefore be encountered due to signals being picked up by the I.F. system.

An intermediate frequency of 1,600 kc. is also advantageous from the standpoint that it permits a wide audio band-width to be passed without the necessity of over-coupling the transformers or decreasing the gain. This allows reception of the high-fidelity programs which are available on the high frequencies from many U.-S.W. broadcast stations. A metal cabinet was used to house the complete Hi-Fi Adapter.

### CONSTRUCTION

The location of parts will be observed from the photographs of the Hi-Fi Adapter. The 2-gang variable condenser is mounted approximately in the center of the front panel with the coil switching assembly directly beneath this condenser. The condenser and coils are mounted directly on the front panel. Two chassis were formed out of 18-gauge



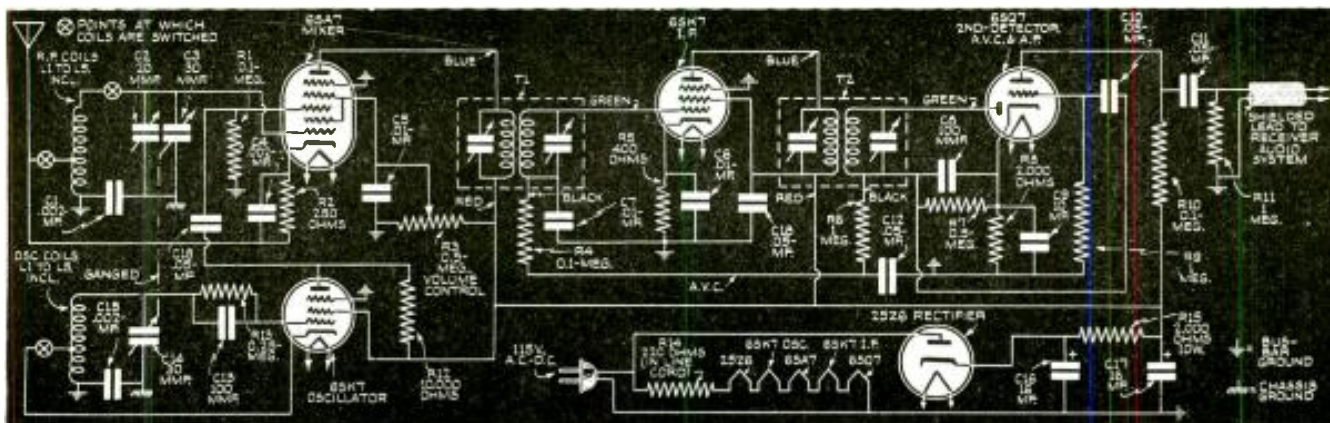

Fig. 1. Schematic diagram of the 5- to 20-meter Hi-Fi (and telly-sound) Adapter which may be connected directly to the audio channel of any existing receiver. The Adapter is completely self-powered.

# TELLY-SOUND ADAPTER

*Shortwave Superhet. Adapter, along lines suggested by R. D. Washburne, for which however are subject to sideband cutting by the R.F. and I.F. sections of a high-fidelity radio program directly into the hi-fi A.F. section of any radio set.*

F. J. GAFFNEY

aluminum (the size, etc., are shown in the drawings, Fig. 2). The chassis on the left has the power supply and the 6SK7 oscillator tube mounted thereon. Mounted on the right-hand chassis, is the mixer tube, the I.F. transformers, I.F. amplifier tube, and 2nd-detector tube.

In laying out the parts, considerable time was spent in positioning the apparatus so as to make the high-frequency leads as short as possible, especially those associated with the tuned circuits. Bare solid wire should be used for connecting the coils with the tuning condensers; and bare wire should be used for connecting the tuning circuits to the grids of the amplifier and mixer tube. This is important, for if the capacities of these circuits change, the oscillator frequency will also shift.

The actual construction of the Hi-Fi Adapter may be conveniently divided into 3 parts. Of course the first thing to do is to mount the respective apparatus on each of the 2 chassis. These 2 chassis then may be wired separately before they are connected to the front panel. The 2-gang tuning condenser and the coil assembly are then mounted on the front panel and wired. The 2 chassis are then mounted to the front panel and held in their respective positions by the controls (regeneration control and antenna trimmer condenser).

As is the proper procedure in A.C.-D.C. circuits, the chassis and the cabinet should not be connected to either side of the light line, and consequently, a ground bus insulated from the chassis and cabinet should be employed for the negative side of the "B" lead. It will be noted in the wiring diagrams that this bus-bar ground is indicated with the ordinary ground symbol, while the chassis ground is indicated with diagonal lines on a horizontal line. Bypass condensers are used between the ground bus and the chassis so that, as far as R.F. potentials are concerned, the chassis and cabinet will be the ground potential, thus eliminating any body capacity when tuning the adapter.

## HOW TO USE

The output lead from the I.F. system of the Hi-Fi Adapter is designed to be connected to an audio amplifier of the home radio receiver, and thus, the Adapter may be used with any radio set. In many receivers a 6F5 tube is employed for the 1st audio stage. In such cases, the upper output shielded lead on the adapter is connected to the grid cap of this tube and the shield is connected to the chassis of the receiver. In

case other tubes are used for the first audio system, the shielded lead should be connected to the grid of the tube, while the shield in all cases goes to the chassis of the receiver. As the adapter has its own power supply, no connections to the receiver's power supply are required.

Under the List of Parts will be found the data concerning turns used on the various coils and the frequency range, which is covered by each. In tuning in shortwave stations, set the band-switch for the desired range and with the regeneration control retarded (turn counter-clockwise to about central position), turn the main dial slowly until the station is heard. The regeneration control may now be advanced  
(Continued on page 179)

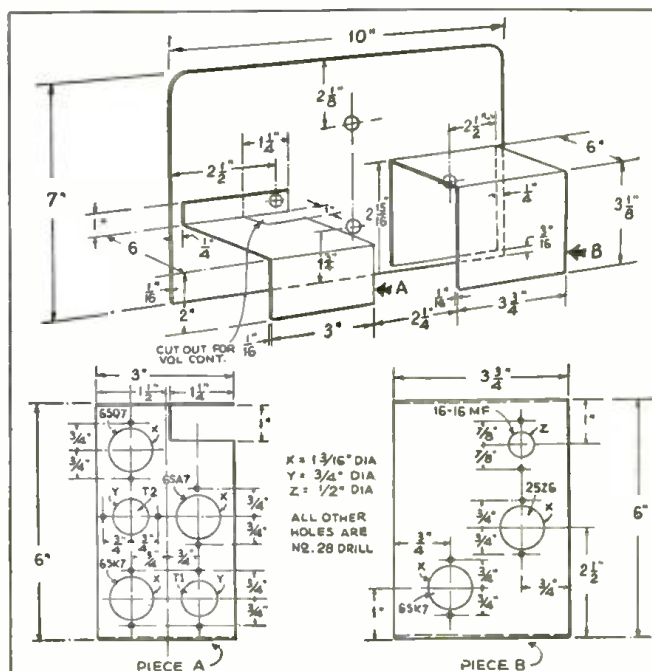
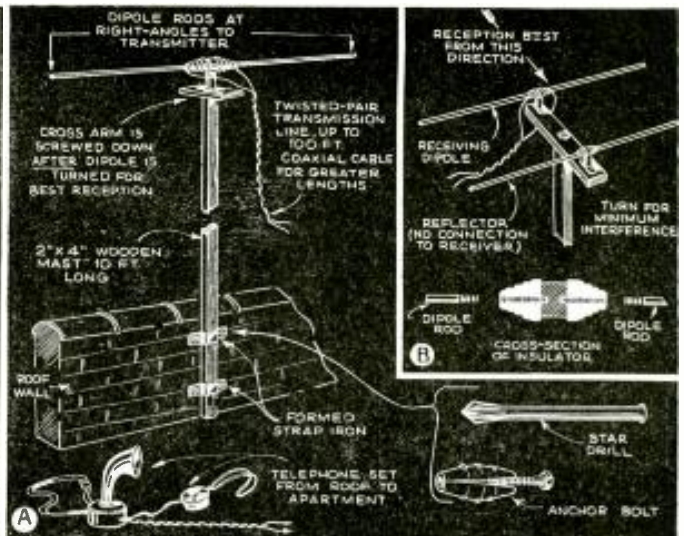

Fig. 2. Specifications for making the front panel and sub-chassis of the Adapter.



The English manufacturer, Ekco, has produced the television service car illustrated above for use in London and environs. Every device required by the Serviceman for the installation and maintenance of television receivers is on hand. An extensible ladder is topped by a television antenna.



(Photo at left—Radio-Press Service.)

Fig. 1. A—Ordinarily, the dipole is broadside to the transmitter; a telephone set, though, is useful in double-checking with a helper at the receiver. B—Like the receiving dipole, a reflector when it is used, consists of 2 separate rods.

## Getting Into TELEVISION SERVICING

Television has surged ahead at lightning speed, leaving many a radio Serviceman wondering just where he fits into the picture; perfected telly sets are literally in the Serviceman's lap, and he wonders to what extent his expert knowledge of home-radio sets will serve him. RADIO-CRAFT commissioned Mr. Sicuranza to supply these elements of telly servicing.

CHARLES SICURANZA

**N**OW that Television has rounded the well-known corner, the radio servicing fraternity will probably divide into 3 groups, namely: (1) those who will not bother with Television at all; (2) those who will specialize in installation and the simpler servicing jobs in the customer's home; and, (3) the group consisting of highly-trained men who will choose the service

laboratory and specialize on the "tough" jobs.

### A COMPARISON

Today's Television is not for tinkerers. It is a brand new and highly intricate art upon which years of effort and millions of dollars have been spent. Unfortunately, Servicemen have had no hand in the development of Television as they had with Radio in the early days. Television has burst forth from the carefully-locked doors of the laboratory and caught a lot of us W.P.D.

What to do! A frantic rush to the nearest television school might be one answer to a lot of the boys. However, the men who have managed to keep abreast of developments know that there is not much difference in the actual servicing procedure itself—rather the difference lies in the test equipment necessary to do the job right.

Modern television sets must be built to high standards of accuracy to produce an acceptable "picture" (image), and therefore, all components must be of better grade and much closer tolerance than in the usual sound receiver. For this reason, service problems encountered at the start will in 90 per cent of the cases be due to defective tubes. The remaining 10 per cent will be due to major breakdowns or antenna trouble.

On the other hand—it will be admittedly more difficult to do any kind of

repair work on television sets, mainly because there are more groups of circuits to handle, than in any broadcast receiver.

### TYPICAL TELLY SET

A typical sight and sound job will have anywhere from 15 to 35 tubes scattered through the following circuits:

Antenna, R.F., mixer, oscillator; branching out, there are the video I.F. amplifier (1 to 4 stages) and sound I.F. amplifier, usually of 1 stage feeding into the sound 2nd-detector, 1st A.F. and power output. . . . At the video 2nd-detector, the R.F. carrier is removed, leaving only the video frequencies, ranging from 10 to 4,000,000 cycles per second. This tremendous span of frequencies must be amplified without attenuation or phase shift by the video amplifier, the final stage of which modulates the cathode-ray tube control-grid, anywhere from absolute darkness to maximum brilliancy in accordance with the variations in the image signal.

Mixed in with the video signal we have a Vertical and Horizontal synchronizing impulse (sent out from the transmitter as part of the image). The Horizontal and Vertical impulses pass through a "Synchronizing Selector and Separator Circuit" which separates these 2 impulses and passes them on to their respective sweep circuits. In some sets you will find that the separated impulses are further amplified by a tube

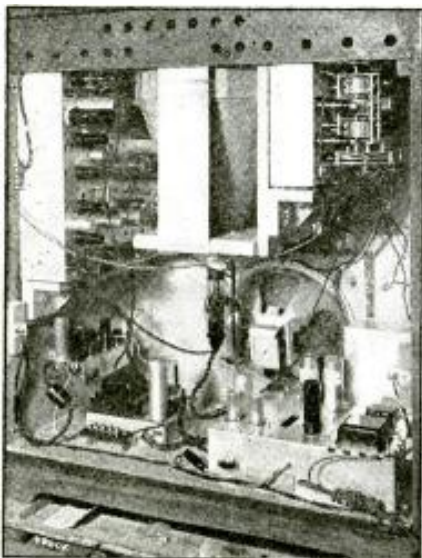

Rear view of an RCA Victor home television receiver. In the rack in the center is the large tube, on which image is reproduced. Speaker is underneath.



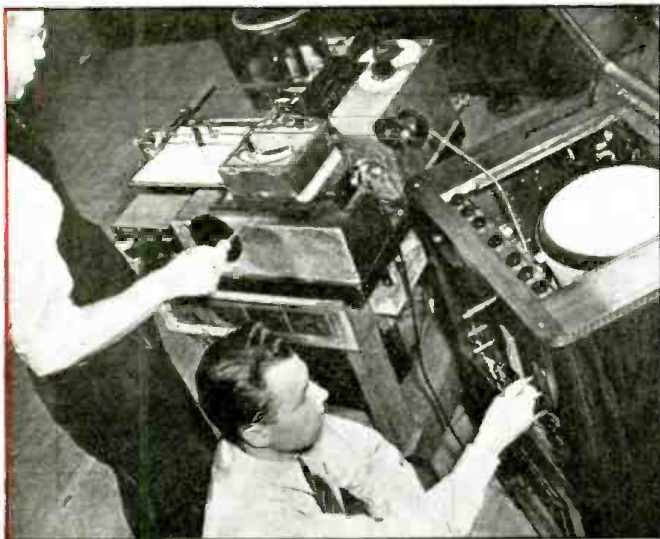

Giving an RCA Victor home telly set its final factory check-up. Instrument at left tests delicate circuits, reproducing its findings on the paper shown in the instrument. (This is a companion view to the photo reproduced on the cover of July *Radio-Craft*.)

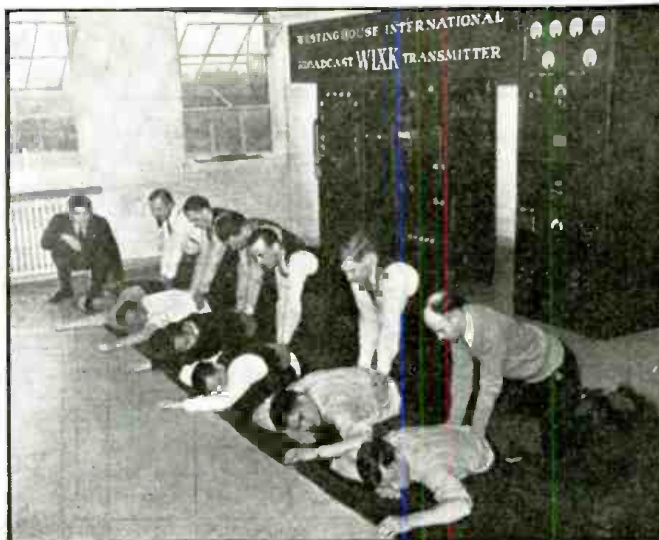

Telly service companies, and schools, teach first aid. Even technicians at Westinghouse broadcast stations must learn the gentle art of resuscitation from high-voltage shock; it's part of a course in first aid which nets certificates from the American Red Cross.

(or tubes) before being applied to the sweeps. The "Sync. Separator" and the "Sweeps" will probably, for the present, be the least understood of all the circuits in the set. However, careful and continuous study of all available diagrams will help you to deal intelligently with individual cases.

The sweep circuits will usually consist of a pair of sawtooth oscillators feeding into amplifiers which in turn feed either the cathode-ray deflecting plates or *yoke*, thereby producing the "field" (*raster*) or rectangle of light on the tube screen.

Then there will be a low-voltage and a high-voltage power supply, plus a network of controls which must be properly adjusted initially on installation.

When working on the receiver, extra precautions should be taken in handling the image tube. *Never* handle the tube while power is on. *Never* lay down the tube (while still hot) on a metal table or on top of tools, etc. Sudden contraction of the glass envelope will cause a small crack which will rapidly widen into an open break. On the larger tubes of 9-inch and 12-inch size, atmospheric pressure on the tube may exceed 5,000 pounds per sq. inch. If such tubes are dropped or hit they explode *inwardly* with great force, and glass shards flying outward can easily cause serious injury. So—handle these large tubes with the same respect accorded to hand grenades.

#### INTERFERENCE

Interference problems as a rule must be solved in the customer's home. In the broad sense, interference can mean anything which mars the image. Distance between transmitter and receiver plus the contour of the terrain between them have a direct bearing on signal strength. The stronger the signal, the better the image. Obviously, the very best antenna, placed at the highest point within line-of-sight of the transmitter and properly turned, will give the clearest image.

All this may be nullified, however, if tall buildings or hills are interposed in the signal path. Under these conditions, with the signal weakened, the local electrical noises may predominate and mess up the image in the same manner that static ruins sound reception.

Further, the signal may be reflected and arrive at the antenna out-of-phase, producing "ghosts" or double images. Automobiles passing nearby may cause a momentary "snow flurry" on the image tube. In aggravated cases of ignition interference, the image may seemingly "tear" in any direction. A weak signal is usually also responsible for the image slipping out of synchronism.

No doubt you have had some experience in aligning high-fidelity sound sets for "flat-top" response to the usual band-width of 15 kc. Well, get set to do some "flat-topping" to the extent of 2,000 kc., which is about the minimum band-width that will give an acceptable image. This wide band-pass is made possible by newly-developed I.F. transformers which are "peaked" at about 12 mc. and are overcoupled so that there is a double hump 2 mc. above and below the 12 mc. "peak." The "flat-top" is obtained by leveling off the double hump with shunting resistors across the I.F. windings. This "peaking" job should always be done in strict accordance with the manufacturer's instructions.

With experience, Servicemen will develop their own favorite methods of tracing trouble, but in any event the smart thing to do is to sectionalize the circuits into groups, and then test one group at a time.

#### INSTALLATION

For "outside" work you will need an assistant, an ultra-high-frequency oscillator, a portable phone system, a knowledge of how to put up a dipole antenna so that it will "give," and a high-resistance, high-voltage voltmeter.

Dipole antenna masts should be at  
(Continued on page 178)

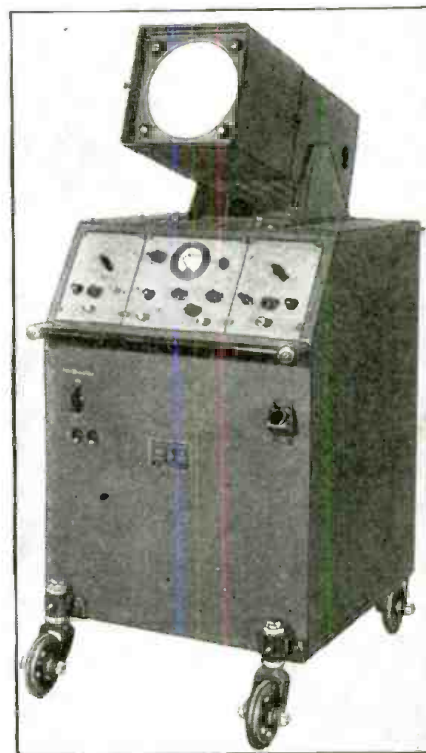

The RCA type 136-B special cathode-ray oscillograph illustrated here is designed for both visual and graphic analyses of weak video waveforms over a frequency range of 30 to 2,000,000 cycles. The image is sufficiently large for good photographing.

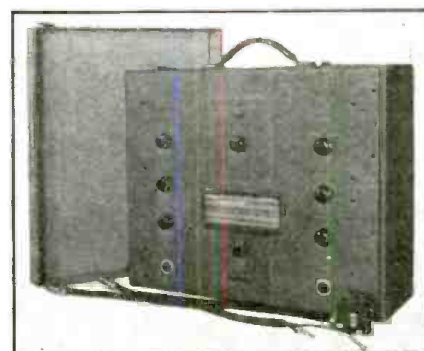

RCA's new video sweep oscillator enables the television Serviceman to adjust amplifiers to provide the necessary wide band response.

## STEWART-WARNER 6-TUBE MODEL A-6 "AIR-PAL" (Chassis 07-31)

3-Tube Superhet.; Automatic Volume Control; Extended Broadcast Band; 70-, 35- and 12-V. Tubes Used; 115-V. A.C.-D.C. Operation

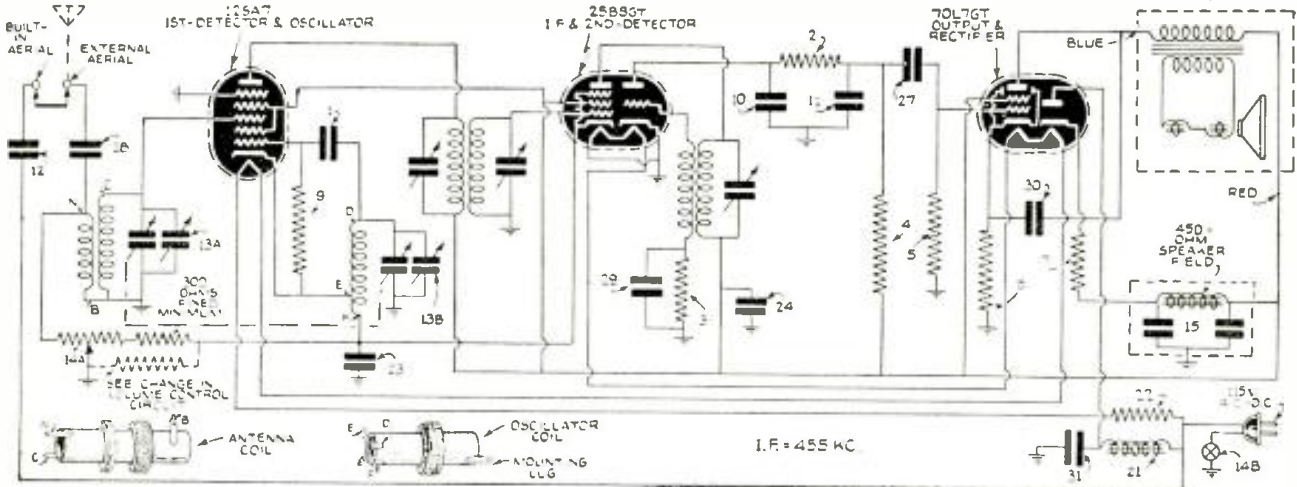

Schematic diagram of Stewart-Warner model A-6 "Air-Pal" (07-31).

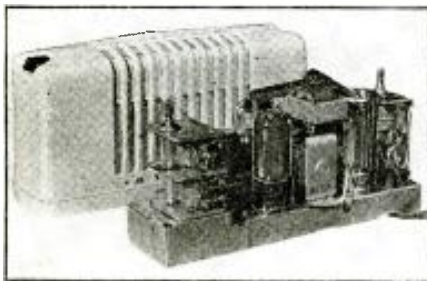

The thin Stewart-Warner "Air-Pal" with vertical tuning and volume control knobs. Note its small size (compare with the tubes).

- 1—condenser, 100 mmf.
- 2—resistor, 33,000 ohms, 1/4-W.
- 3, 4, 5—resistors, 0.47-meg. (ea.), 1/4-W.
- 7—resistor, 50 ohms, 1 W.
- 8—resistor, 100 ohms, 1/2-W.
- 9—resistor, 68,000 ohms, 1/4-W. (ea.)
- 10, 11, 12—condensers, 260 mmf. (ea.), 500 V.
- 13A, 13B—tuning condensers, 2-gang.
- 14A, 14B—volume control, 20,000 ohms.

- 15—twin condenser, 20-20 mf., 150 V.
- 21—R.F. choke coil.
- 22—resistor, 65 ohms, 2 W.
- 23, 24—condensers, 0.1-mf. (ea.), 600 V.
- 27—condenser, 0.01-mf., 600 V.
- 28—condenser, 0.004-mf., 600 V.
- 29—condenser, 0.05-mf., 600 V.
- 30, 31—condensers, 0.02-mf. (ea.), 600 V.

### ALIGNMENT PROCEDURE

For alignment an output meter and an accurately calibrated signal generator are required.

- (1) Solder the output meter leads from output plate (P1) to screen (S) of the 70L7GT tube (see voltage chart). The leads must be soldered since the bottom cover must be replaced during alignment. The output meter leads can be brought through the power cord opening.
- (2) Connect the ground lead of the signal generator through a 0.25-mf. condenser to some portion of the chassis in the vicinity of the gang condenser.
- (3) Remove the connector between the antenna terminals on the bottom of the set.
- (4) Turn the volume control to the maximum volume position and keep it in this position while aligning.

Separating this lead from the others surrounding it at the base of the 25B8GT tube will also help.

### CHANGE IN VOLUME CONTROL CIRCUIT

On early releases of this model, a volume control was used which required a 4,700-ohm resistor connected as shown by the dotted lines in the circuit diagram. In later production sets, a volume control with a different taper was used so the 4,700-ohm resistor was not required. This later volume control carries the same part number.

When replacing a control using the resistor with a later type control, the connections are the same but the 4,700-ohm resistor is omitted. Only the new controls are carried in stock by Stewart-Warner.

The Built-In Antenna incorporated in this receiver will generally give very satisfactory

Dummy Ant. in Series with Sig. Gen.	Sig. Generator Connection to Receiver	Signal Generator Frequency	Receiver Dial Setting
0.1 Mf. Condenser	Lug on bottom gang condenser	455 kc.	Any point where it does not affect signal
200 Mmf. Mica Condenser	Terminal on bottom (Terminal nearest back of chassis)	1500 kc.	1,500 kc.
200 Mmf. Mica Condenser	Antenna Terminal on bottom (Terminal nearest back of chassis)	1500 kc.	Tune to 1,500 kc. Generator Signal

Trimmer Number	Trimmer Description	Type of Adjustment
1	2nd I.F.	Adjust for maximum output. Then repeat adjustment. (If the circuit oscillates, see precautions under heading "I.F. Oscillation".)
2-3	1st I.F.	Adjust trimmer for maximum output.
4	Broadcast Oscillator (Shunt)	Adjust trimmer for maximum output.
5	Broadcast Antenna	Adjust for maximum output.

- (5) The tuning knob should be adjusted so that the nick which appears on the outer part of the knob is accurately centered and points away from the chassis when the gang condenser is in full mesh.

**CAUTION:** When alignment has been completed, you must replace the fibre insulator sheet at the bottom of the cabinet. Failure to do so will leave the metal chassis exposed and due to the circuit design of A.C.-D.C. receivers, may subject the customer to an electric shock if he touches any grounded object.

### I. F. OSCILLATION

When aligning this set, I.F. oscillation may be encountered if the following precautions are not observed:

- (1) Keep the bottom cover plate on tightly during alignment.
- (2) Keep the signal generator leads as far from the chassis as possible in order to prevent unnecessary feedback.
- (3) Connect the ground lead of the signal generator through a 0.25-mf. condenser to some part of the chassis in the vicinity of the gang condenser.
- (4) Keep the orange lead of the volume control away from the 2nd I.F. transformer.

results in localities where powerful broadcast stations exist. This Built-In Antenna will function when the terminals on the bottom of the chassis are connected together. In cases where noise is excessive or greater sensitivity is desired, remove the jumper connecting these terminals and connect an external antenna to the terminal marked "External Area." This is the terminal nearest the back of the set.

### BUILT-IN ANTENNA SYSTEM

The Built-In Antenna Condenser No. 12 couples the primary of the antenna coil to one side of the power line, which acts as the antenna. The R.F. choke No. 21 is an iron-core choke whose impedance is high at broadcast frequencies. This choke serves to prevent condenser No. 31 from bypassing the signal voltage picked up by the power line. It also prevents feedback into the antenna circuit of radio frequency energy generated in the set itself.

When aligning this receiver, the jumper connecting the antenna terminals on the bottom of the set should be removed. This will prevent picking up signals which might interfere with the alignment procedure.

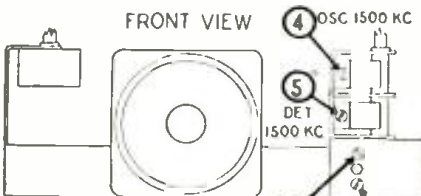

Front and underchassis views showing locations of various aligning trimmers.

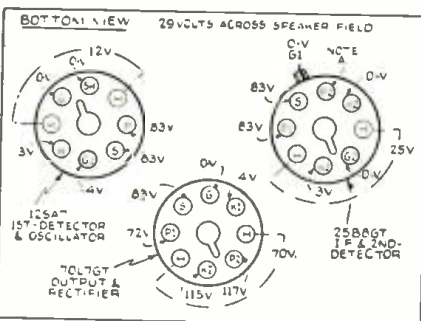

Socket voltages taken with volume control set at maximum position, antenna grounded and dial tuned to 540 kc. Line voltage measured to chassis is 117 V. NOTE: Due to high resistance of resistor No. 4 only a small voltage will be read on a meter having a resistance of 1,000 ohms/volt.



**AUTOMATIC RADIO MFG. COMPANY "3-in-1" MODELS P-57 AND P-58 PORTABLES**

Combined Battery and A.C.-D.C. Operation; 5-Tube Superhet. (when used on 110 V. A.C.-D.C.; 4 tubes when used with batteries); Automatic Volume Control; Built-In Loop Antenna; No Changeover Switch Required for A.C.-D.C. or Battery Operation; P. M. Dynamic Speaker.

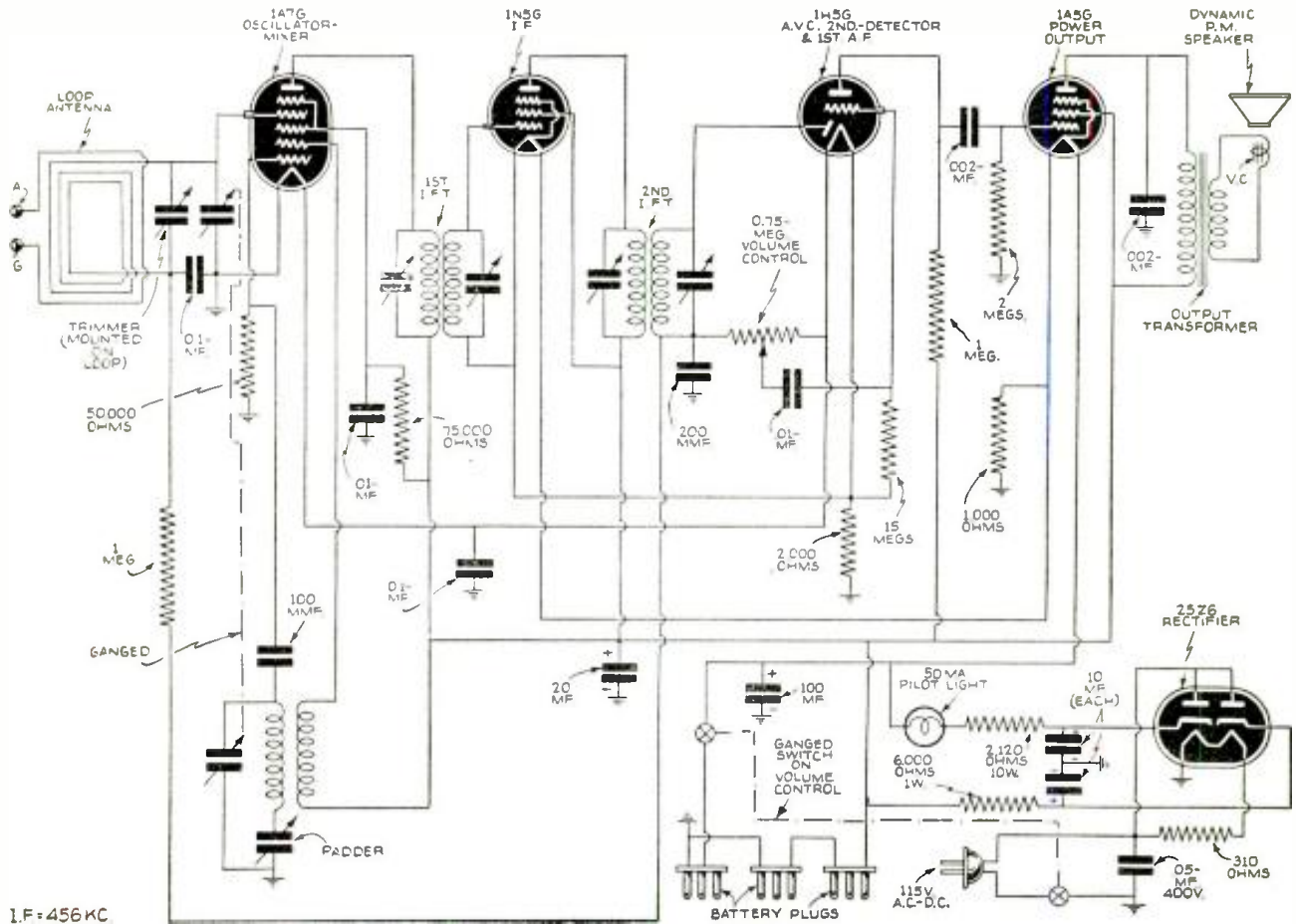

Schematic diagram of the Automatic models P-57 and P-58.

**ALIGNMENT PROCEDURE**

Feed a 456-kc. signal to the control-grid of the 1A7G through a 200-mmf. dummy antenna and adjust the trimmers on the I.F. transformers for maximum response. Keep the gain from the signal generator as low as possible during all alignment work.

For R.F. alignment adjust trimmer across the loop antenna with a 1,400-kc. signal, for maximum response. This trimmer is reached through a hole in the rear of the cabinet covered by a plug button. It is the upper one of the two such buttons. Adjust the oscillator padding condenser with a 600-kc. signal. This trimmer may be reached through a hole in the rear of the cabinet by removing the lower plug button.

**BATTERY REJUVENATION**

The manufacturer claims that when the set has been used a long time on battery power and the batteries are getting weak, if the set is then used for some time on the electric line power, the batteries become rejuvenated and come back to full voltage, so that a great many more hours of service can be had from a set of batteries used in this radio than can be had from batteries of the same type used in other battery-operated radios.

**110 TO 125 VOLT D.C.**

As with all other radio sets that operate from 110 to 125 volt D.C. lines, there is a right and a wrong way to put plug into the socket. When this set is operated on a 110 to 125 volt D.C. line, it will operate with plug in socket either way. If it is in the wrong way neither the set nor the batteries will be damaged, except that the set will be operating from battery power, using up batteries, which will be shown by the red marker light not glowing even after a few minutes' operation. The plug should be put in correctly (by reversing one-half turn) so that marker light glows as soon as tubes heat up.

**GENERAL INFORMATION**

No switching is necessary in changing from battery to electric current operation. If the set is not plugged into electric current supply (power line) it operates immediately from its batteries. If it is plugged into an electric socket it starts operating immediately from its batteries, but after about three-quarters of a minute, as soon as tubes heat up, it automatically switches over to electric current supply and batteries no longer supply power to the set. When the set takes its power from the electric line it is shown by a glow of light behind the red marker on dial. If electric-power plug is removed while the set is playing it keeps right on playing from its

batteries, but the marker light goes out showing that the line is not supplying power. If desired, the set can be operated from A.C. or D.C. lines even with all batteries removed.

The electric power cord tucks into a compartment underneath the case which is covered by a snap-fastened flap.

Referring to the diagram, it will be observed that the entire "A" supply is derived from the 25Z6 rectifier when this set is operated from electric light lines. In order to eliminate any possible ripple being introduced into the circuit via either the grid circuits, which obtain their bias voltages as drops across resistors connected in shunt to the filaments connected in series, or directly from the filaments due to a fluctuating "A" voltage, an extremely-high-capacity electrolytic condenser is connected from the high side of the filaments-in-series to ground. The capacity is 100 mf. One-half the rectifier supplies "A" voltage and incorporates a resistance-capacity network including a 10-mf. electrolytic condenser, the 100-mf. unit previously mentioned, and the pilot light and a 10-W. power resistor in series; the other half of the rectifier incorporates a second resistance-capacity filter network having a 20-mf. and a 10-mf. electrolytic condenser, one on either side of a 1-W. resistor. This arrangement is effective in eliminating hum. The 310-ohm main filament dropping resistor is incorporated in the power cord.

The observing Serviceman will immediately notice that the power supply for operating this battery portable from the electric lines is of such a universal nature that it can be used to electrify other battery portables since most of these portables use practically the same tube complement. It will of course be necessary to arrange the filament circuit for series operation when in use on the lines and the original parallel connection when used with batteries. A simple switching arrangement can easily take care of this.



The Automatic combined A.C.-D.C. and battery portable models P-57 and P-58.

# THE LATEST RADIO EQUIPMENT

The address of any mentioned manufacturer will be sent on receipt of a self-addressed, stamped envelope. Mention of item number hastens reply.



Ultra-high-frequency converter. (1773)

## ULTRA-HIGH-FREQUENCY CONVERTER (1773)

(Wholesale Radio Service Corp.)

THIS new ultra-high-frequency converter developed by Frank Lester (shown in photo), of the above company, may be used with any receiver capable of tuning to some frequency above the standard broadcast band. It is claimed that the unit provides overall sensitivity equal to or better than that of the receiver itself at the low-sensitivity part of its normal range. Its sensitivity is apparent even at 5 meters. (See schematic at the end of this department.)

Moreover if the receiver is tuned to 4,000 kc. or higher, infinite image selectivity is provided, thereby eliminating the repeat points. The instrument employs a type 1853 as T.R.F. stage, a 6K8GT converter, and an 80 rectifier. All power is self-contained, making the unit absolutely independent of the receiver. The converter is available in kit form with all necessary 5- and 10-meter plug-in coils, etc.

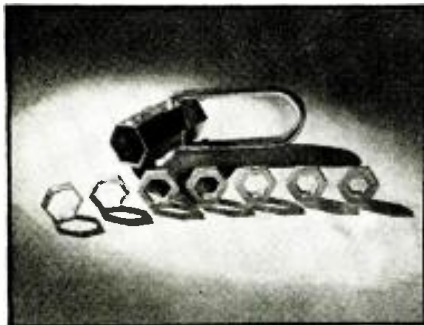

New tool for auto-radio Servicemen. (1774)

## NEW TOOL FOR AUTO-RADIO SERVICEMEN (1774)

(Star Machine Manufacturers, Inc.)

AT LAST, a socket wrench that loosens or tightens nuts even when 6 ins. or more of the bolt extends beyond the nut—as is the case with the bolts on most auto-radio receivers, and car heaters. The tool has been cleverly designed with a swivel handle which speeds action even in uncomfortable quarters. The tool contains within itself 7 sizes of sockets, accommodating the following inch-size bolts: 7/16, 1/2, 9/16, 19/32, 5/8, 11/16 and 3/4. Any of these sockets may be slipped out and into accurate position by merely pressing a spring clip. The tool is exceptionally compact and takes up very little room in the Serviceman's kit.



Latest television antenna. (1775)

## LATEST TELEVISION ANTENNA (1775)

(Consolidated Wire & Associated Corps.)

THE LATEST dipole-type television antenna illustrated in this department employs 2 telescoping brass rods, shown in the closed position, which allows for adjustment to the exact frequency to be picked up by the television receiver. The antenna is provided with a 75-ft. length of low-loss transmission line, the impedance of which will match the input, it is claimed, of every television receiver. The impedance of the line is 100 ohms.



15-W. P.A. system. (1776)

## 15-W. P.A. SYSTEM (1776)

(Bell Sound System, Inc.)

THIS job incorporates a 15-W. high-gain amplifier employing inverse feedback for reduction of harmonic distortion and an improved tone compensator which aids in eliminating audio feedback difficulties. Three input channels with separate volume controls provide for simultaneously mixing 2 microphones and a phono pickup. Beam power output tubes, a tap switch for selecting impedances are among the other features. The entire system is compactly arranged in 2 portable carrying cases, the amplifier in one and the 2—10-in. P.M. dynamic speakers in each of the halves of the other.

## VISUAL FREQUENCY MONITOR (1777)

(Browning Laboratories, Inc.)

THE LATEST instrument for amateurs from the "House of Browning" is the visual frequency monitor illustrated in this department. It is so designed that amateur bands are spread over approximately 240 degrees on a 5 1/2-in. laboratory-type dial calibrated in megacycles. A tuning eye is used as an accurate zero-beat visual indicator.

## KONTAK MIKE WITH HAND VOLUME CONTROL (1778)

(Amperite Company)

ANY NUMBER up to 5 of these units can be connected in parallel and the volume of each one adjusted, at the instrument, without affecting the volume on the other instruments. The output of the Kontak unit is -40 db. It can be operated into any standard amplifier and, so the manufacturer claims, into most any radio set.

## "SUPER-POWER" CONE PROJECTOR (1779)

(Atlas Sound Corp.)

THIS air-column trumpet, designed for 8-in. cone speakers, follows an exponential design which results in an adequate loading of the cone diaphragm for improved efficiency and power-handling abilities. It is suitable for use in all outdoor P.A. applications and industrial installations. Total length is 36 ins.; bell diameter, 24 ins. The bell section is made of heavy gauge aluminum and the speaker housing is a heavy steel pressed pot.

(Continued on page 189)

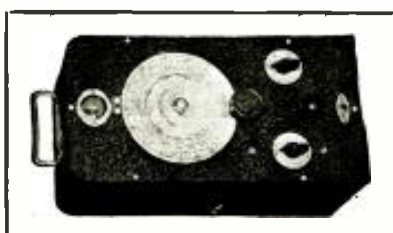

Visual frequency monitor. (1777)



Kontak mike with hand volume control. (1778)



"Super-power" cone projector. (1779)



All the worthwhile  
Radio Trade News  
of the past Month—  
Digested for busy  
radio men.

# RADIO Trade Digest

A PLEDGE: — To  
print the important  
news of the radio  
industry; to review  
major news events;  
to help point a path  
to radio profits.

IMPORTANT HAPPENINGS OF THE MONTH IN THE RADIO INDUSTRY

No. 12A

SEPTEMBER, 1939

No. 12A

## ARTHUR MOSS HEADS PARTS DISTRIB. ASSN.

*Exec. Sec'y Issues Statement  
on Policies to Boom  
Profit on Parts*

Arthur Moss, Executive Secretary of the National Radio Parts Distributors Assn., Inc., has issued a statement on the group's aims and purposes. Under the heading of "Cooperation Insures Profit," Mr. Moss outlines these as follows:

*(Continued on page 185)*

## FROM FINCH

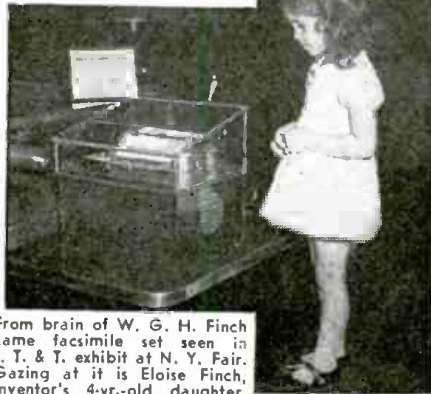

From brain of W. G. H. Finch came facsimile set seen in I. T. & T. exhibit at N. Y. Fair. Gazing at it is Eloise Finch, inventor's 4-yr.-old daughter.

## SURVEY OF NYC SHOWS TYPICAL SET MARKET

*Answers Questions as to  
Distribution and Age  
of Radios*

New Yorkers are supposed to be as varied as the communities whence they came. However complex their background in nationality and taste, their likes and dislikes, they seem to be agreed upon one point, and that is 99.3% of them believe a radio is a necessity for

*(Continued on page 184)*

## "IS TELEVISION HERE?" THESE CHEERING FIGHT FANS THINK SO!



Photos like these give best answer as to what public thinks of television. In picture below, all save a few concentrate on the screen, bringing them images of Baer-Nova fight in window of J. E. Shaneck's shop, N. Y. C. Inside, favored few crane at screen (note body-English of lad at left). Good programs will bring bigger boom sooner!





## MEN OF MERIT! MEET 5 MORE WHO MAKE THIS MONTH'S HEADLINES



L. to R.—After 4 yrs. leave of absence, Henry Hutchins has returned to direct National Union's selling program. Formerly sales chief of Thordarson, Charles P. Cushway has become sales mgr. of Webster-Chicago. Edward J. Kelly has been made mgr. of radio & record mfg. & production eng. of RCA's Camden plant.

E. T. Hamilton, mgr. of same co.'s material controls, now manages all warehousing & shipping at Camden, too. After 6 yrs. with Thordarson, W. S. Hartford has become that co.'s Gen. Sales Mgr. RTD offers congratulations to these executives. Pictures of more will appear next month.

### Sales Helps and Deals

*Aids To Profits, as Devised  
By Industry Leaders*

**Electric Soldering Iron Co.,** Deep River, Conn., has a new display board, featuring its 3 most popular irons for home and radio use.

**The Acousticon Div. of Dictograph Products Co.,** N.Y.C., is offering 138 prizes for best names for its new private magazine. First prize is a \$600 all-expense trip for 2 to either the N.Y. or Frisco Fair; 2nd is \$250; 3rd, \$100; etc.

**Aerovox Corp.,** New Bedford, Mass., has yellow-black-&-white posters featuring troubles of college lad trying to listen in while roommate uses elec. razor. The sheet plugs the co.'s radio noise eliminators.

**Allen B. Du Mont Labs.** is offering its dealers a handsome illustrated novelty folder in 3 colors to promote telly sets. Place for dealer's imprint on rear, giving invite for demonstration at store.

Smart idea to plug early A.M. show is being used by **WTMJ,** Milwaukee, (Continued on page 183)

### Personal

*These men are worth knowing;  
meet them here.*

**CHARLES B. PEIRCE** is directing the expansion program of **Radiotechnic Lab.,** Evanston, Ill., as that co. adds other instruments to its line of tube testers. **H. P. MANLY,** the co.'s founder, continues in charge of engineering, sales & development.

*New officers of the Radio Servicemen of America are:* **GEORGE DUVALL,** N.Y.C., pres.; **KENNETH VAUGHAN,** Johnstown, Pa., v.-p.; **DONALD STOVER,** Freeport, Ill., secy.; **LEE TAYLOR,** Chi., treas.; **JOE MARTY,** Jr., exec. secy.

*New directors of the Natl. Radio Parts Show are:* **N. S. SHURE,** A. A. **BERARD,** H. E. **OSMUN** & **JEROME J. KAHN.** Jerry will serve as secy.-treas. **KENNETH A. HATHAWAY** re- (Continued on page 183)

### Changes & New Addresses

*Save stamps & time! Address  
your mail right the first time!*

**INDEPENDENT PNEUMATIC TOOL CO.,** of Chicago, has opened a branch at 1544 Broadway, Denver, Colo. **C. A. Turnquist** is in charge.

### \$'s & N<sup>o</sup>. 's Dept.

**Zenith,** for yr. ending Apr. 30, showed operating profit of \$1,477,134; balance on this date was \$2,699,605.

**Televiewers** at N.Y. World's Fair exceeded 1 million after 5 wks. of operation.

Continuing upward trend for 18th mo., **NBC** take was \$3,702,102 for May. This is 8.4% over preceding yr.; 4% over preceding mo.

Dividends of 87½¢ a share on the 1st pf.; \$1.25 on the "B" pf.; \$3.50 on the Cumulative Conv. 1st pf. were declared by **RCA** for the Apr. 1—Jun. 30 quarter.

Upturn still on in radio, as excise tax shows, being \$279,302 for May—41.7% above preceding yr.

Downward slipped exports, though only a bit, as April biz was \$1,601,507. But sets showed an upturn. The breakdown:—

Sets (#)	39,774
Sets (\$)	\$743,684
Tubes (#)	522,985
Tubes (\$)	\$236,915
Parts, etc.	\$434,130
Speakers (#)	37,418
Speakers (\$)	\$50,862
Xmtrs	\$135,916

Employment situation happier than last yr., for March was 29.9 better than '38. Payrolls were 47% up, & average weekly wage in radio factories had increased 13.2%.

## THEY'RE TRYING TO HELP YOU MAKE MORE MONEY; WON'T YOU TAKE IT?

New RCA display (shown on Model U-123) features fact that line will reproduce television sound when used with video attachment; also boosts record sales & radio programs.

The Clarostat bulletin board & folder rack, described last month, is shown at right; it's an attention-catcher & sales-getter!

New Red-White-&-Blue carton for Solar tubular paper capacitors will pull the customer's eyes right out of his head & onto your shelves!





# AN EDITORIAL

By Vic Mucher

Sales Mgr., Clarostat Mfg. Co.

Our parts industry is threatened as never before with price slashing. Hardly a month goes by but another volume control or resistor or other component pops up with lower prices as its main sales appeal. The fact that such devices call for specialized engineering over a long period is usually overlooked by newcomers bent on utilizing purely mechanical skill for something which seems to have a brisk market already established. The electrical end may be pretty much neglected.

## Price Cutter

Now the truth remains that established parts manufacturers have spent years attaining their present quality. They have long specialized. They have spent fortunes in research and engineering. Consequently, when they sell a given part, a certain percentage of the cost is necessarily reflected in research and engineering. Ah! The price-slasher would save you that percentage! But wait a minute . . .

For that slight percentage, which usually matches the difference between established brand parts and nondescript parts, you are getting a definite insurance covering satisfactory performance. You are assured that the established brand parts will perform satisfactorily. Plenty of case histories attest to the dependability of such parts. Can you afford to pass up such insurance for the sake of a few pennies?

## Extra Penny

I for one doubt it. Yet many jobbers today are being coaxed to cheaper parts either to make a few extra cents on each sale, or more likely to secure price leaders. Either way, their Servicemen customers may be getting parts of unknown or little known reputation. And that means taking long chances—gambling with results—in the absence of that insurance which backs long-established parts.

Because servicing is mainly a matter  
(Continued on page 184)

### ALLENTOWN SERVICEMEN VISIT ARCTURUS



E. M. Frank Elec. Co. of Allentown, Pa., sponsored trip of 13 local Servicemen to plant of Arcturus Radio Tube Co. in Newark, N. J., to meet the boys. L. to R.—4th Row—Henry Klitsch, Abbot Feindel (Chief Eng.), A. E. Lyle (Plant Supt.), Al Klitsch, Frank Langstroth (Eng.); 3rd Row—Walter Heiney, Gus Campbell (Asst. Chief Eng.), Charles Thomas, Warren Wolson, Herb Chun (Eng.), H. E. Erickson (Asst. Sales Mgr.); 2nd Row—Ed Schliecher, J. A. Stobbe (V-P & Gen. Mgr.), Ray Hinkle, Walter Merkel, George Eisenhard, Warren Schreiber; 1st Row—Joe Walters, Earl Moger, Carl Frank, Art Cert (Asst. Sales Mgr.).

### SERVICE SIDE VIEW OF OCHILTREE ELECTRIC IN PITTSBURGH



### BUILDING WITHIN BUILDING HOUSES LAFAYETTE HAM "PARADISE"



Sound-proof enclosure on sales floor houses complete Ham line of Lafayette.

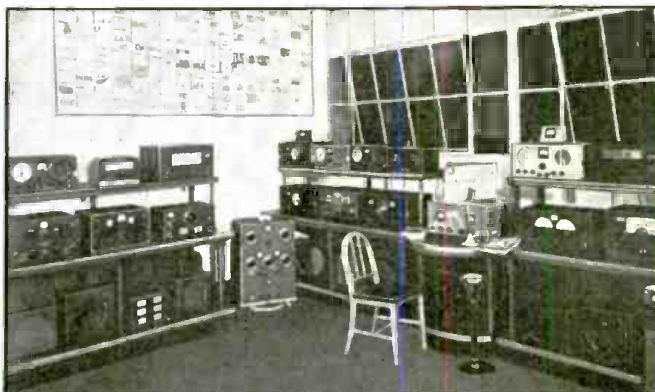

Inside are displayed receivers by RME, Hallicrafters, National, Howard, et al.



CARRYING CASE MAKES MIDGETS PORTABLE

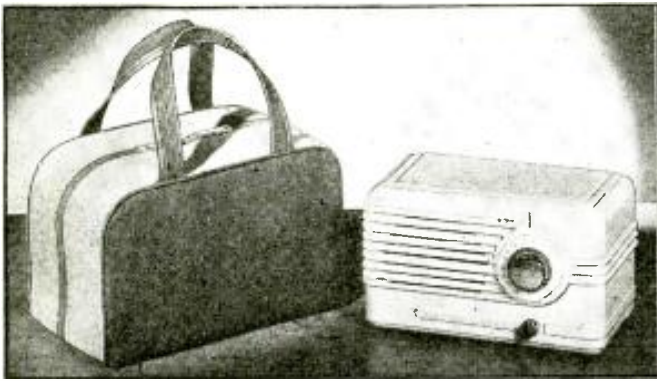

Specially made for Westinghouse Series WR166 and WR165, this carrying case weighs 3/4-lb.; is waterproof & lockable; makes midget set easily portable; was made in answer to numerous requests; should sell well all year 'round.



Kadette Radio Div. of Int'l Radio Corp., Ann Arbor, Mich., sold to W. Keene Jackson (former gen. sales mgr.) & group of associates; bringing out new line. . . . Zenith pres. predicts end of outdoor aerials (his co. makes sets with built-in ones, y'know) . . . Get RMA bulletin 180 for list of new officers, too long for here, but A. S. Wells, of Chi., is still pres. . . . Assn. is also renewing "Buy RMA" plan, for more biz between members . . . Another drive by Assn. is to have fewer types of tubes in use (T. G.!) Those new 15-inch c-r (television) tubes, rumored at Raytheon, will give images 10 x 12 inches. . . . You can tell the Mason & Risch electronic pianos from their regular models by the volume control pedal; it's the 3rd. . . . Maybe we shouldn't snitch, but Clough-Brengle is mfg. the test eqt. which bears another mfr.'s veddi-veddi famous trademark. . . . "Electronic peddler" is what Doc Baker, of G-E, calls television, seeing its possibilities as an adv. medium.

(Continued on page 183)

OFF THE PRESS

To Keep You Informed

DIAGRAMS OF RADIO TUBE BASE CONNECTIONS. Tung-Sol Lamp Works, Newark, N.J. 93 pp. Nearly 200 tubes are covered in this vest-pocket size book. (25c from mfr.)

TUBE COMPLEMENT BOOK. Hygrade, Sylvania Corp., N.Y.C. 165 pp.; plus 56 pp. 1938-9 supplement. Tells what tubes each set uses, & gives freq. of I.F. on supers. (25c from mfr. or jobber, complete; supplement only, 10c.)

VARIAC TRANSFORMERS. General Radio Co., Cambridge, Mass. 4 pp. Specifications, illustrations, prices & descriptions of these voltage-varying transformers.

RADIO SPECIALS. Allied Radio Corp., Chicago, Ill. 4 pp. Bargains on apparatus. (Example, 8-watt P-A system complete for \$19.95.)

OSCILLOGRAPH. TECHNICAL BULLETIN # 100. Hickok Elec. Inst. Co., Cleveland, O. 16 pp. Describes operation & use of "oscillograph" ("scope"), with many illustrations. (Free from mfr.)

(Continued on page 184)

MAGAZINE RACK & RADIO



Midget "Fireside" set of Stewart-Warner has A.V.C., covers 540-1,725 kc., is mounted in rack which will hold copies of Radio-Craft, Radio & Television, & other mags. if people want 'em.

BATTERY PHONO-RADIO



A 4-tube super. with xtal pickup & phono is G-E's contribution to summer entertainment. Battery operated, it weighs 19 1/2 lbs. complete. Covers 540-1,600 kc.; lists at \$36 in East.

Television Tips

"Big Screen"

Baird engineers demonstrated c-r television images 9 x 12 feet, for theater use. Images were clear & reasonably bright. Detail was good when viewer was minimum of 25 ft. from screen. Tube has life of about 100 hrs.; this brevity not important from theater standpoint. Still at press time, no theaters have as yet installed the large-screen equip't. Reason probably is the shortage of programs that are of sufficient interest to warrant theaters' expenditures. NBC broadcast of *Pirates of Penzance* was high spot of non-sports shows, but most special telly dramas (e.g., *The Honeymoon*) are mental level of many afternoon radio sketches (i.e., sub-zero).

"Revolutionary"

Philco announced 2 improvements which (in Philco's opinion) were little short of revolutionary. First, flat end on telly tube was considered by most observers as interesting but unimportant. On 10-in. tube, glass end must be about 3/8-in. thick. Second, offset electron gun will, engineers of Philco claim, prevent ion blemish (brown spot) from appearing on end of c-r tube. This is desirable, but most observers failed to get very excited about it. Interesting in this mfr.'s line is sight job which pushes sound through any best recr. Telly sound is converted to 510 kc. & radiated to other set tuned to that wave. But telly set including sound costs but \$10 more than this model. Don't engineers do the funniest things?

"Telly on D.C."

New line of G-E telly sets was demonstrated. Images were excellent, as expected. Most startling fact was that sets were being run from D.C. lines through converters. They synched perfectly.

"Exceeded by 100%"

According to Du Mont Labs., "public interest in television has exceeded wildest expectations by 100%".

(Continued on page 183)

NEW WESTON PHOTOMETER



For dealers with photo sidelines, this new \$24 Model 715 Weston meter should prove swell seller. Has unusually wide range, is easy reading, accurate, rugged. This make generally considered standard.



## UNIVERSAL 32-W NEUTRALIZED-FEEDBACK P.A. AMPLIFIER

(Continued from page 155)

and the "B+" terminal are automatically switched from the 115 volts A.C. power supply to the 6-volt storage battery and dynamotor. Special care has been exercised in the selection of the contacts employed in this relay to insure life-long and trouble-free performance. The relay coil consumes approximately 250 milliamperes while in the "holding" position.

**4-Position Mixer.** The amplifier accommodates 2 high-impedance microphones and 2 high-impedance phono pickups. Each pair of inputs is electronically mixed in the first 6SC7. This type of circuit provides for independent mixing of any one or more of the input signals. The overall gain of the amplifier is approximately 125 db. The phono input circuits provide approximately 80 db. gain.

**Tone Control Circuit.** The frequency compensating circuit provides for individual high-frequency or low-frequency cut-off. This type of circuit has been selected for average P.A. applications, inasmuch as it is both economical and highly practical. For voice announcements, low frequencies should be attenuated so as to improve intelligibility of speech. For musical reproduction, however, the high frequencies should be attenuated if excessive record scratch is present.

**Universal Operation of the Turntable.** The phono motor employed is a special unit, which operates equally well from 6 volts D.C. or 11 volts A.C. The change-over for operation of this unit is likewise controlled by the master relay. A magnetic frequency-compensated pickup is employed so as to safely withstand any abnormal abuse which this equipment may be subjected to.

### THE CLASS B OUTPUT STAGE

Good quality, high power, and minimum distortion are assured in the output of this

amplifier by the generous use of inverse feedback, plus a feedback type of cathode drive, and a well-regulated choke-input power supply. All of these factors greatly contribute to the unusual performance of the amplifier.

It is well known among design engineers, that the driver of a class B stage should preferably be of the lowest possible impedance. The use of a 6EGG driver tube was seriously considered in the design of this amplifier, but it was found that not only did this tube furnish insufficient power, but its recommended plate-to-plate load of 14,000 ohms was entirely too high for satisfactory operation. The 6V6G tube was selected because of its high power handling ability and comparatively low inherent distortion (which practically cancels in the cathode degenerative circuit).

The primary of the input transformer looks into an impedance which is equal to

$$\frac{10^6}{\text{mutual conductance}} \text{ which equals } \frac{10^6}{4100} =$$

242 ohms. This low impedance represents an ideal source of driving power for a class B input transformer.

A universal output transformer is employed to insure proper matching to a wide variety of loads.

The care exercised in the design of this amplifier is reflected in its performance, high efficiency, fool-proof operation, good overall response, high-gain, and economy of operation.

The author will be pleased to answer any questions relative to this amplifier, if inquiries are addressed c/o *Radio-Craft*, and are accompanied with a stamped and addressed envelope.

*This article has been prepared from data supplied by courtesy of Amplifier Company of America.*

## HAM "AMOS" AND PILOT "ANDY"

(Continued from page 142)

lay League. A beam of indirect light, synchronized with Gosden's rooftop aerial, shines across it, to show which way the aerial is sending its signals. When this directed energy is pointed right, 4EDD, Coral Gables, sends word through that W6QUT is arriving in Florida "like a ton of brick."

Gosden's auto set looks like an ordinary dashboard radio receiver. But a flip of the switch converts it into a transmitting unit of W6QUT. A microphone comes out of the storage space in the dash panel, and is plugged-in near the speedometer. In the space under the auto instruments, converter apparatus is installed. Under the turtle deck of the roadster, there is a battery charger, and a 15-watt-input transmitter. The aerial is a telescopic steel plume which spires from the rear bumper.

Gosden keeps a complete log of all his shortwave activities—whether he's at home, or out driving around in his car. In it are such amateur expressions as "Hi" for hello, "XYL" for wife, "88's" for love and kisses, and "button factory" for place of business. The boys call the Columbia studios where they do their daily stint a "button factory." And there's also, one may be sure, plenty of off-the-record "Amos 'n' Andy kidding.

"Amos" has to get his revenge for all that bull-dozing on the air some way or other after all these years.

## OPERATING NOTES

(Continued from page 153)

### PHILCO MODEL 5 AUTO SET

If you have trouble in locating the cause of low volume and distortion in this model, after having made the usual tests, examine the speaker for dust between the voice coil and pole piece.

### PHILCO (Misc.)

Several models use an insulator on the filter-condenser can in order to be able to connect a negative bleeder resistor between the negative can and the chassis. In several cases, after being called on the complaint of "bad tone on my Philco," we found that the owners had removed the can insulator, or that a condenser had been replaced without using the insulator, thus depriving the set of any grid bias.

### GRUNOW, MODELS 8A, 801

**Complaint:** No reception, or low volume and distortion. Check the 1-mf. screen-grid by-pass condenser in the 78-tube 1st-detector stage for a short.

### GRUNOW MODELS 7A, 700, 701

When you have a bad case of fading or intermittent reception in this model, look for an open or intermittent-open 0.1-mf. by-pass condenser in the R.F. and 1st-detector stage. This condenser is a dual unit in a small can mounted on the back of the antenna coil shield. If one is not familiar with

(Continued on page 169)

DEALERS • SERVICEMEN • AMATEURS • P. A. SPECIALISTS BUILDERS

**Ready! The 1940 ALLIED CATALOG 100% RADIO! EVERYTHING AT LOWEST PRICES**

**204 PAGES! The Biggest Exclusively All-Radio Catalog**

Never before a Radio book like this! 204 pages in 5 complete sections, for Dealers, Service Men, Amateurs, Sound Specialists and Builders—plus a big new Bargain Section where prices meet their Waterloo! Sets, Kits, P.A., Ham gear, testers, the most complete parts listing ever published—all arranged for quick reference, all at lowest prices. Your FREE copy is ready.

**FREE Send Coupon**



### NEW SETS!

60 new Knight models, 4 to 12 tubes, with all the newest features—"Air Maxnet," Gem-Ioid Dials, etc.—recorder-phono-radio combination, 1-tube electric phonograph, 5-, 7-, 11 tube phono-radios—all sensational radio values!



### NEW PUBLIC ADDRESS!

3 complete new lines—"Economy," "Standard," and "De Luxe"—13 new systems, 6 to 65 watts, new styling and performance—new "mikes," latest recording equipment! Investigate our new Time Payment Plan.



### NEW KITS!

Dozens of new kits of all types—new Television Kit, new Beginners 1, 2, and 3 Tube Kits, new Wireless Phono and 112 Volt Kits—and diagrams and projects for 100 kits.



### NEW TESTERS!

New television-equipment testers, Rider Volt-Ohmmyst, new 110-volt tube testers, latest Analyzers, Oscillographs, set testers, Meters, etc.—all leading lines at lowest prices. The most complete lines ever offered.



### NEW HAM GEAR!

Largest Ham Catalog ever—all latest receivers, new Skyrider "Defiant," etc., Rotary Beam equipment, television equipment—all standard lines at lowest prices. New Time Payment Plan—lowest carrying charge, easiest terms!



## Big New PARTS SECTION!

More than 55,000 radio items—the biggest Radio Supply listing ever! Hundreds of new tube types—duplicate parts, batteries, aerials, tools, books, etc. And a big, new Bargain Section. For biggest values, see ALLIED'S new 1940 Catalog today!



ALLIED Radio Corporation, Dept. 2-J-0, 833 W. Jackson Blvd., Chicago, Illinois.

Send your FREE 204-page 1940 Catalog.

Name .....

Address .....

City ..... State .....

Please Say That You Saw It in RADIO-CRAFT

INTRODUCING THE NEW

SCOTT

Masterpiece  
CUSTOM BUILT

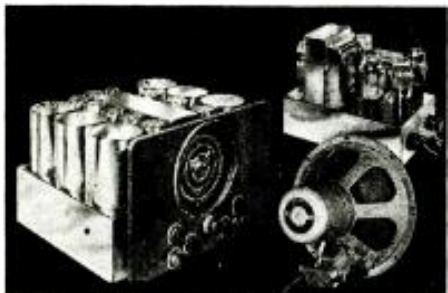

Equipped to Receive  
TELEVISION SOUND



"This is one of the most amazing, superbly toned, precision built instruments ever produced in my engineering laboratories. Final tests revealed such tremendous capabilities on both broadcast and short wave bands that there was only one way to describe it . . . a Masterpiece! I believe its performance is unapproached by any other make of radio in the world today."

"WORLD'S FINEST RADIO"

"All the specialized knowledge gained in 15 years of designing and custom building super-powerful, high fidelity receivers for musicians and critical listeners the world over, has been incorporated in this remarkable precision instrument. Radically new (years ahead) engineering, plus many exclusive features developed and patented by my own laboratories, have produced in the Masterpiece a degree of performance that the owner of the average production type radio would say was impossible! Yet, it costs no more."

*E. H. Scott*  
President

30 DAYS TRIAL • GUARANTEED 5 YEARS

Hear the magnificent tonal realism of this new custom built SCOTT. Budget plan if desired. Sold direct from our laboratories only. Send coupon today.

GET SPECIAL OFFER!



E. H. SCOTT RADIO LABS., Inc.  
4404 Ravenswood Avenue  
Dept. 2499, Chicago, Illinois

Send all facts, order blank and special introductory offer on the new Scott Masterpiece.

Name .....

Address .....  
STUDIOS: Chicago, New York, Buffalo, Detroit, Los Angeles

THE COIL YOU WANT!

whether it's an Iron Core High Gain I.F. Regenerative Iron Core IF or any other coil used in communications or broadcast receivers or in UHF transmitters, you will find it in the latest catalog of DX precision made coils. DX Coils are used by well known receiver manufacturers, engineers, service men, set builders, etc. Teachers of radio and students praise DX color coded circuits as easy to understand. Leading radio jobbers have DX Coils or can get them for you at attractive prices. Send 15c today with your longest name and receive DX Deluxe catalog illustrating DX coils in full size photos.



DX RADIO PRODUCTS CO.,  
1575-A Milwaukee Ave., Chicago, Ill.

Also manufacturers spiderweb loop antennas used on latest model receivers.

MAKING A 4-TUBE BATTERY "PERMEABILITY PORTABLE"

(Continued from page 137)

holes were drilled according to the sizes given in Fig. 2. Do not mount the speaker and bracket until all the wiring has been completed.

ALIGNMENT

If the parts specified at the end of this article are used and the circuit diagrams carefully followed the set should feel "alive" when the batteries are connected and the switch turned on. To align the set you will need an oscillator which can produce frequencies of 465 and 1,400 kc. Keep the gain of the service oscillator signal as low as possible. Feed a 465 kc. signal through a 200 mmf. condenser (dummy antenna) through the grid cap of the 1N5G tube and adjust the trimmers of the 2nd I.F. transformer for maximum response. The final adjustment

of any trimmer should always be in the closing (clockwise) direction. Repeat the same operation with the signal applied to the grid-cap of the 1A7G tube and adjust the trimmers of the 1st I.F. transformer for maximum response. Now set the dial pointer of the permeability tuner to exactly 1,400 kc. on the dial scale and apply a signal of 1,400 kc. from the service oscillator to the external antenna post through a 200 mmf. dummy antenna, and adjust the oscillator trimming condenser for maximum response. That completed, adjust the R.F. trimmer (directly below the oscillator trimmer) for maximum response. Now repeat the entire procedure for greater accuracy. Finally, disconnect the service oscillator, plug in the plate antenna and the set is rarin' to go!  
(List of Parts on next page)

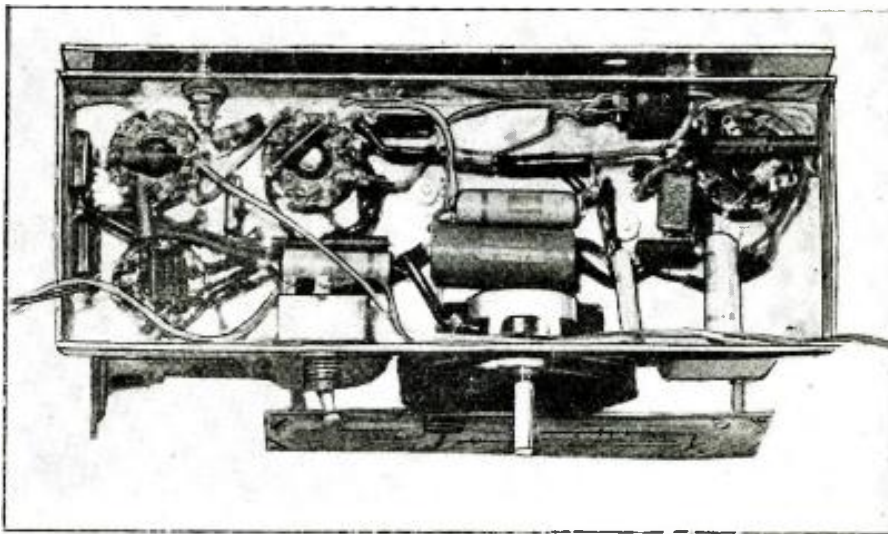

Fig. C. Underside view of the portable showing arrangement of resistors and condensers.

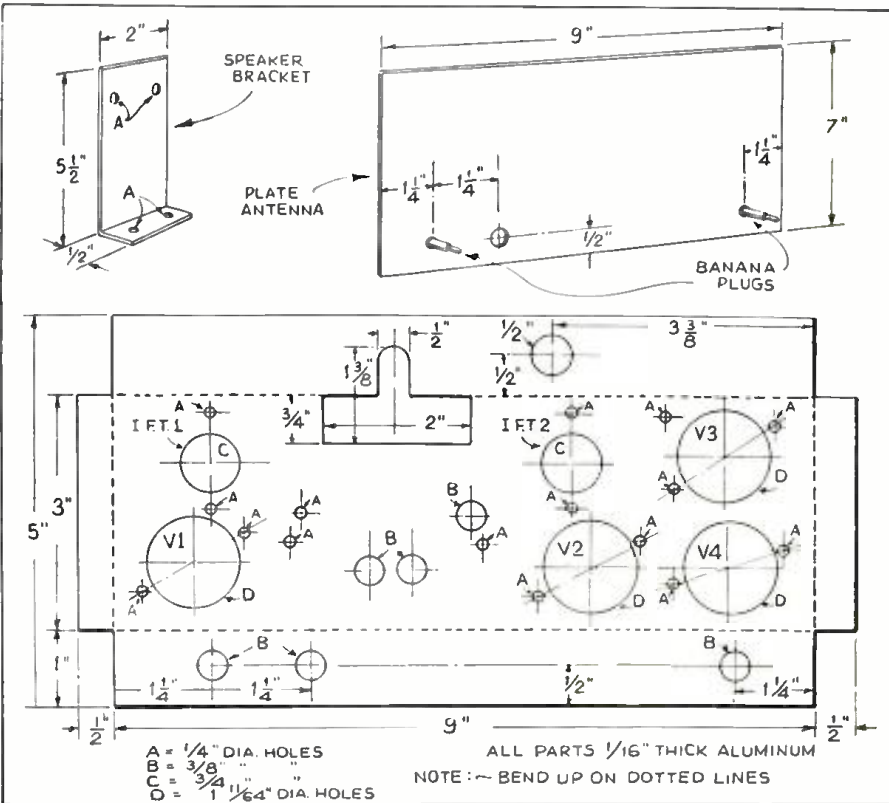

Fig. 2. Complete specifications for making the sub-chassis, speaker bracket and plate antenna for the "permeability portable."

Please Say That You Saw It in RADIO-CRAFT



**LIST OF PARTS**

One Aladdin permeability tuner (this includes C4, C5, L1 and L2).

**Condensers**

One Cornell-Dubilier, 25 mmf., C1;  
 One antenna plate (see text), C2;  
 One Cornell-Dubilier, 0.02-mf., 400 V., C3;  
 One Aladdin, type 8-161, 70 mmf., C6;  
 Two Cornell-Dubilier, 0.01-mf., 400 V., C7, C11;  
 One Cornell-Dubilier molded, 50 mmf., C8;  
 Three Cornell-Dubilier molded, 100 mmf., C9, C10, C13;  
 One Cornell-Dubilier, 0.005-mf., 400 V., C12;  
 One Cornell-Dubilier, 0.002-mf., 400 V., C14;  
 One Cornell-Dubilier molded, 250 mmf., C15;  
 One Cornell-Dubilier, 10 mf., 150 V., C16.

**Resistors**

One I.R.C., 70,000 ohms, 1/2-W., R1;  
 One I.R.C., 0.2-meg., 1/2-W., R2;  
 One I.R.C., 3 megs., 1/2-W., R3;  
 One I.R.C., 50,000 ohms, 1/2-W., R4;  
 One volume control, 1 meg., R5;  
 One I.R.C., 5 megs., 1/2-W., R6;  
 One I.R.C., 1 meg., 1/2-W., R7;  
 One I.R.C., 2 megs., 1/2-W., R8;  
 One I.R.C., 800 ohms, 1/2-W., R9;  
 One I.R.C., 10,000 ohms, 1/2-W., R10.

**Coils**

One Aladdin I.F. transformer, type S-101, 465 kc., T1;  
 One Aladdin I.F. transformer, type S-200, 465 kc., T2.

**Tubes**

One Raytheon type 1A7G, V1;  
 One Raytheon type 1N5G, V2;  
 One Raytheon type 1H5G, V3;  
 One Raytheon type 1A5G, V4.

**Miscellaneous**

Two Type G1227 Goat tube shields;  
 One Utah type 3P P.M. dynamic speaker;  
 One Utah output transformer to match a single type 1A5G tube (25,000-ohm plate load);  
 Four Amphenol type M1P8 sockets;  
 Two aluminum panels 7" x 10" (supplied by Wholesale Radio Service Co., Inc.);  
 Miscellaneous hardware, jacks, grid caps, etc.;  
 Two Eveready Type 723 3-volt "A" Batteries;  
 Two Eveready Type 733 45-volt "B" Batteries.

**OPERATING NOTES**

(Continued from page 167)

this model, he might not observe the way this condenser is connected. The wires come from the bottom of the condenser and run through the coil shield to the coil. The top of the condenser has tie points for the tone control condenser.

CLARENCE J. TABER.

**STEWART-WARNER MODEL 91-64 CHASSIS (Used in Phonograph Model 91-649 Receiver) TESTING**

When the phonograph pickup leads are disconnected, as this model chassis is removed from the cabinet for testing, the set will not operate unless the proper connections are made at the phonograph terminal strip. The 2 outside terminals must be connected together and the center terminal must be grounded to the chassis.

**TRACING WIRING**

In tracing the wiring in this chassis and in most other current Stewart-Warner sets, you must remember that certain tube sock-

(Continued on page 175)

# Audolyzer

## Model 562



**Are you holding back because you think that real DYNAMIC TESTING EQUIPMENT is too expensive for you? If so, you'll welcome the new SUPREME 562 AUDOLYZER because it will make all the important tests of equipment selling for twice the price, do it more quickly and easily, yet is easy on your pocketbook!**

**You will like this instrument because of its amazing simplicity. Every stage in a radio receiver can be DYNAMICALLY tested with just one probe. With the SUPREME AUDOLYZER you hear the signal from a built-in speaker with controlled volume—its presence or absence—its strength or weakness—its distortion or purity. WITHOUT LOOKING AT ANY METER, MAGIC EYE or other indicating device! You can start at the antenna post of the receiver and work back. You can rapidly determine the exact point of intermittent reception in any receiver section or part. Most amazing, you can determine, without a manual, the use for which every tube is placed in any radiol! You can measure the frequency of an unknown R.F., I.F., or oscillator signal. You can measure comparative gain or loss in R.F. and I.F. tubes**

**and transformers. You can find the location, compare amount and frequency of receiver's hum. With the high resistance 15 megohm input Vacuum Tube Volt meter built in the Audolyzer, you can measure A.V.C., A.F.C., D.C.Grid, D.C. Screen Grid, D.C.Plate, power supply voltage—in fact, any D.C. voltage without disturbing the receiver's operation! What is more, you can use your present Cathode Ray Oscilloscope in conjunction with the Audolyzer in viewing the demodulated signal for distortion, overloading, etc.**

**The AUDOLYZER can be used to check the audio-amplifier in a receiver or a P.A. installation, check speakers, etc. The AUDOLYZER can be electrically divided into two sections so that you can use two probes at a time for checking intermittents, working from the second detector's input and output toward the loudspeaker and antenna or vice versa. In fact, more down-right profitable, quick diagnosing can be done with the SUPREME AUDOLYZER than any other competitive system. Your radio jobber is stocking the SUPREME AUDOLYZER. Use it on SUPREME'S FIVE DAY FREE TRIAL OFFER. Buy it on the S.I.C. Easy Payment Plan—just a few pennies a day. Let it prove itself right on your own work-bench because you can operate it profitably after only a few minutes study.**

### SUPREME

SUPREME INSTRUMENTS CORP.  
GREENWOOD, MISSISSIPPI, U. S. A.  
EXPORT DEPT. Associated Exporters Co. 145 W. 45th Street, New York  
Cable Address: LOPREN, N. Y.

**MAIL COUPON TODAY!**  
 SUPREME INSTRUMENTS CORP., Dept. C-8,  
 Greenwood, Miss.  
 Please RUSH me newest information on SUPREME AUDOLYZER and other completely new SUPREME 1939 Models.  
 Name \_\_\_\_\_  
 Address \_\_\_\_\_  
 City \_\_\_\_\_ State \_\_\_\_\_

**A NEW BOOK ON PUBLIC ADDRESS**

An important announcement about the greatest book on the subject of sound and allied subjects appears on the inside front cover of this issue. **TURN TO THE ANNOUNCEMENT NOW!**

FREE!

HAMMARLUND  
NEW "39"  
RADIO CATALOG

The latest Hammarlund catalog with complete data, illustrations, drawings and curves on the entire Hammarlund line. Address Department RC-9-39 for your free copy.

HAMMARLUND MFG. CO., INC.  
424-438 West 33rd Street, New York City

SOLAR

quality above all

ALL TYPES OF  
FIXED CAPACITORS  
FOR RADIO AND  
TELEVISION

Catalog on Request

SOLAR MFG. CORP. - Bayonne, N. J.

Please Say That You Saw It in RADIO-CRAFT

**QUICKER, EASIER WAY  
TO TRAIN FOR  
ELECTRICITY  
12 Weeks Practical WORK  
IN MY CHICAGO SHOPS**



**WANT TO EARN MORE MONEY?**

Of course you'd like a good-pay job. But wishing won't get it for you. Dreaming won't do it. Doing can! And I'm ready to help you on your way to a start.

I'm ready to make it easy for you to get 12 weeks of real shop training in ELECTRICITY — training that can help you toward a better job.

This is no correspondence course I'm talking about. You do actual work right in my Chicago shops—real work on real generators, motors and dynamos. You do house wiring and wind armatures. You work in many other branches of electricity. And right now I'm including valuable instruction in Diesel, Electric Refrigeration and Air Conditioning.



**HOUSE WIRING**  
only one of the many branches you "Learn By Doing"



Coyne has first class instructors to teach you the simplest things to start with and they have the equipment to show you these things as you advance  
Ben Rickman, S. Car



Everything was just as stated in literature. And by Coyne methods plenty of instructors to take care of everything, easy to learn. I really was satisfied with Coyne Training  
J. Halyk, Canada



**I'LL FINANCE YOUR TRAINING**

If you are short of money you can get this training first—then pay for most of it later in 12 easy monthly payments, starting 60 days after your 12 weeks training period is over.

If you need part-time work to help out with expenses while training in my shops, my employment department will assist you. And after graduation, you'll get lifetime employment service. Mail the coupon today and I'll send you my big free book filled with interesting facts and pictures of students at work—doing the same things you will do. I'll also tell you about my "Pay After Graduation" Plan and how many of my students earn while learning. Fill in, clip, and mail the coupon today. H. C. Lewis, President.

**COYNE ELECTRICAL SCHOOL**  
500 S. Paulina St. Dept. 69-78C. Chicago



**MAIL THIS COUPON NOW**

H. C. Lewis, President  
COYNE ELECTRICAL SCHOOL  
500 S. Paulina St., Dept. 69-78C, Chicago, Ill.  
Please send me free your big catalog and full particulars of your "Pay After Graduation Plan"—also other facts.

NAME.....  
ADDRESS.....  
CITY.....STATE.....

**MAILBAG**

(Continued from page 152)

resistors. I would suggest that you draw the circuit in its simplest form, leaving out all switching arrangements, except possibly the multirange switch, and be certain you have connected the elementary circuit as it should be.

This instrument is essentially a "1 Volt" unit, as you will see that the 0.1-megohm resistor in Sw.1A is connected from grid-return to cathode. This is the fundamental range, all others being obtained by tapping onto the high-resistance voltage divider by means of Sw.1A. If all the resistors in the series are of proper value and connected properly, the instrument *must* work correctly on all ranges, providing the 1 Volt range has been properly set.

It will be found on the A.C. setting that about 1/2-volt will be registered on the meter, when the test leads are shorted. This reading is obtained regardless of the setting of Sw.1A; of course, on the ranges from 10 V. up, this is not serious. This effect is apparently caused by a current flow in the diode circuit, and cannot be eliminated by any simple means. It can be compensated for, however, by making certain the test leads are shorted before setting the 7,000-ohm resistor. The effect is not noticeable on D.C. settings, since the diode section of the 6Q7 is then disconnected.

I hope these notes will enable you to get satisfactory results.

HOWARD G. MCENTEE,  
Glen Rock, N. J.

**SPIES MISTAKE—GIVES OP. NOTES**

Dear Editor:

In the June '39 *Radio-Craft* magazine there is a very apparent error in the schematic of the G.E. Model GB-400 shown on Radio Service Data Sheet No. 255. I am enclosing (below) a small diagram showing correction.

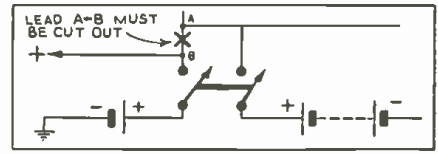

Also in your "Operating Notes" I noticed an insert on the Zenith 4-F-133 sent in by Mr. E. D. O'Neal of West Union, W. Va. There are a great number of these receivers in this locality but in all cases I have run into the defective I.F.'s were definitely open. I have found that the best replacement is the Meissner "Ferrocart" I.F. transformers, the use of which improves both sensitivity and selectivity.

In districts where line voltage runs high the use of Ohmite "Dividohm" vitreous enameled resistors is very effective in reducing the voltage to the desired amount. Ordinary plug-in ballasts seldom reduce the voltage sufficiently. To use the Dividohm simply bolt it in place under the chassis, connect in series with transformer primary, place A.C. voltmeter across primary and move variable slider until the desired voltage is obtained. A 25- or 50-ohm, 100-watt unit, will take care of practically all receivers.

EDGAR RYE,  
Blooming Prairie, Minn.

**A SERVICEMAN'S VOTE**

Dear Editor:

First of all let me tell you, I think *Radio-Craft* is the best magazine the Serviceman

Please Say That You Saw It in RADIO-CRAFT

can buy, and it is the most of anything that he can buy for 25c. Down here we never see half the gadgets that are developed, and can hope to keep up with the whirl of things only through *Radio-Craft*.

Now for a little criticism. In the March issue, the *Radio Month* in Review section, and under the subhead "Censorship," it seems that the N.A.B. and President Lohr of N.B.C. took a panning for their stand against liquor, beer and wine advertising.

I am surprised to see this coming from "Radio's Greatest Magazine," that tries to keep its advertising clean, but pokes fun at a man who tries to keep his medium clean and protect so many thousand American homes that have radios.

I think Mr. Lohr and the N.A.B. directors should be commended for their stand.

C. L. CROMER,  
Cromer's Radio Sound Service,  
W. Columbia, S. C.

**"EXPRESSOR" TROUBLE**

Dear Editor:

In accordance with instructions in the article concerning the "Audio Expressor" in *Radio-Craft* for April, 1938, I have constructed this item using the parts as specified excepting in the power supply.

The "Expressor" works very well in both the expansion and compression positions much as described in your article.

However I find that when the expressor is inserted into the circuit the higher tones are somewhat attenuated in much the same way as though a tone control were being used. I have added a switch which bridges the expressor circuit so that it can be cut off or on at will. In the bypass position the tone is natural and the same as though the phonograph or radio were fed directly into the amplifier. When the switch is opened and the expressor inserted the tone is altered as described above.

I have tried everything which I can think of to correct this condition including the following: Substituting D.C. heater and plate voltages, changing values of individual or combinations of resistors and condensers (although the ones I am using are exactly as specified), varying the applied voltages and changing the circuit of the 6S7G so that it is used as a triode.

Of all these changes the only one which corrected the trouble described was the last mentioned. However when the tube was operated as a triode the expansion and compression action became entirely ineffective and thus made the unit useless in its original role.

As I have had considerable experience in designing and building amplifier systems, preamplifiers, etc., I feel that there is just some little thing which does not come to my attention at the moment, and so I am writing to you since you may have experienced the same trouble and, since then, rectified it. However, if you have not experienced this trouble perhaps you can tell me what may be causing it for me.

Will you please tell me what the various voltages are as applied to the 6S7G in your circuit? Perhaps my trouble may lie there although I believe not. Incidentally changing tubes has not rectified the trouble for me.

Ebensburg, Pa.  
L. P. MCDOWELL,

(This letter was referred to the author, whose reply follows:)



Dear Mr. McDowell:

Replying to your recent letter, the higher tones in the Expressor, as described in the April, 1938 issue of *Radio-Craft* may be attenuated, if the interconnecting lead between the expressor and the amplifier input has an appreciable capacity.

You will note that the output plate load is 1/2-megohm, which approximately equals the internal plate resistance of the tube. Assuming you used a shielded cable having a capacity 2.4 micro-microfarad per foot, you will have an attenuation of approximately 8 db. at 10,000 cycles.

You undoubtedly used an interconnecting cable having a higher capacity.

Naturally, when a tube is operated as a triode, its internal plate resistance drops to 10,000 ohms, so that the shunt capacity of the interconnecting cable becomes negligible at the higher frequency. Of course, the tube will not operate as an expander because of the changing mutual conductance that the grid exerts on the tube when it is used as a triode.

The voltages applied to the 6N7G are conventional in every respect, and can only be accurately measured with the vacuum-tube voltmeter. Your trouble definitely does not lie in voltages if you have followed the circuit diagram.

A. C. SHANEY,  
New York City

ONE READER'S OPINIONS

Dear Editor:

I believe you are interested in what a reader of your publications might think in regard to existing conditions—in radio and in general.

The opening statement in your editorial, "Television Racket," in the January, 1939, issue of "R-C," that the radio industry has been handicapped by unscrupulous promoters, is certainly telling the truth; and making it more clear and definite, just insert the words "National Business" instead of the "Radio Industry" and you have the story of this troubled country.

Your editorial "Radio at the Crossroads" (in the following, March issue—*Editor*) hit the nail on the head. The statement that television will be ready late in April, has called forth the usual cat-calls and pooh-poohs of a number of manufacturers who can see nothing in television and now do their best to knife it.

I have not read anything in regard to the use of facsimile in police radio-equipped cars. Is that being used?

When will the amateurs be permitted to experiment with facsimile? Facsimile transmissions have been on for over a year and the amateurs have not been offered a low-priced kit.

When the use of facsimile does open up, the type printers in use will be obsolete as the 3-gang scanning pen will take the place of the single one.

One model printer (Crosley No. 118), which sells at \$79.50, is priced too high. (You do not have shortwave station W8XE which has a facsimile program on daily at 12:noon to 1:00 p.m., and WHK facsimile 5:00 to 6:00 a.m., listed in the shortwave station list of *Radio & Television*. These stations are in Cleveland, Ohio.)

I would like to see constructional articles on facsimile and television receivers by amateurs and experimenters.

At one time *Short Wave Craft Magazine* (now *Radio and Television—Editor*) was made up of this type of articles on the construction of shortwave receivers and transmitters.

RCA OFFERS THIS P. A. LEADER

AT A  
*New Low Price*

Outstanding RCA Junior Velocity Microphone—the favorite of service and sound engineers everywhere —now available for only . . . . .

\$3450



Take advantage of this new low price! Get this microphone that is so amazingly popular with service and sound engineers —now! It is Model MI-4036—a true velocity unit of small size and light weight with hall-and-socket mounting. One of the family of RCA microphones—many of which are used in major broadcasting studios—as well as by leading motion picture companies.

**SPECIFICATIONS OF MI-4036**  
FREQUENCY RANGE, 50 to 9,000 cycles. OUTPUT LEVEL, -59 db (10-bar-open-circuit). OUTPUT IMPEDANCE, 50, 250, 15,000 ohms. CABLE, 30 feet (less plug). FINISH, Chromium and Black. FITTING, 1/2" pipe thread. NET WEIGHT, 3 1/2 lbs. DIMENSIONS, 7 3/4" high, 2 3/4" wide, 2 1/2" deep.

NEW! RCA PRESSURE MICROPHONE—



Designed for Outdoor Use

This mike is pressure operated with a styrol diaphragm and moving coil element. Extremely rugged, small in size, attractive in appearance. Ball-and-socket joint (with thumb screw clamps) affords easy adjustment. Its frequency range is 60 to 10,000 cycles...output level 54db (10-bar-open-circuit)...output impedance 50 and 250 ohms. Cable less plug is 30 feet long. Has 1/2" pipe thread fitting. Price . . . \$7495

"FB" FOR AMATEURS—This RCA



Aerodynamic Mike

This small, streamlined microphone—is especially suited for close talking. Available in high and low impedance models. Its frequency range is 100 to 8,000 cycles... output level -66 db (10 bar-open-circuit)... 30 feet cable (less plug)... Chromium finish... 1/2" pipe thread fitting or 5/27" fixture thread. Low impedance model (output 250 ohms) is MI-6226, Price \$1995 High impedance model (output 40,000 ohms) is model MI-6228, Price \$2195



Listen to the Magic Key of RCA every Monday, 8:30 to 9:30 P. M., E.D.S.T., on the NBC Blue Network

Plan now to cash in on a huge market with  
**COMMERCIAL SOUND**

RCA Mfg. Co., Inc., Camden, N. J.  
A Service of Radio Corp. of America

ANY SOUND SYSTEM SOUNDS BETTER EQUIPPED WITH RCA RADIO TUBES

**FREE!** Send today for your copy of the new RCA Commercial Sound Catalog... 56 big, illustrated pages.

Commercial Sound Section, Dept. 0-0  
RCA Manufacturing Co., Inc.,  
Camden, N. J.

Please send me my copy of the new RCA Sound Equipment Catalog

Name \_\_\_\_\_  
Address \_\_\_\_\_  
City \_\_\_\_\_  
State \_\_\_\_\_

Why not now, when facsimile is coming into use?

I like your "Radio Trade Digest," "Latest Radio Equipment," and "Radio Month in Review" departments.

MYRON BARKHURST,  
Box 17,  
Jewett, Ohio.

**IN OCTOBER RADIO-CRAFT**  
How to Make A 30-Watt Direct-Coupled Power Amplifier with Volume Expansion  
**DON'T MISS IT!**

**MIND POWER**

**A FREE BOOK**

Develop your personal, creative power! Awaken the silent, sleeping forces in your own consciousness. Become Master of your own life. Push aside all obstacles with a new energy you have overlooked. The Rosicrucians know how, and will help you apply the greatest of all powers in man's control. Create health and abundance for yourself. Write for Free book, "The Secret Heritage." It tells how you may receive these teachings for study and use. It means the dawn of a new day for you. Address: Scribe N.C.H.L.

**The Rosicrucians**  
SAN JOSE —AMORC— CALIFORNIA  
"The Rosicrucians are NOT a religious organization"

Please Say That You Saw It in RADIO-CRAFT



### 3-DIMENSION 2-KW. P.A. AT N.Y. FAIR

(Continued from page 143)

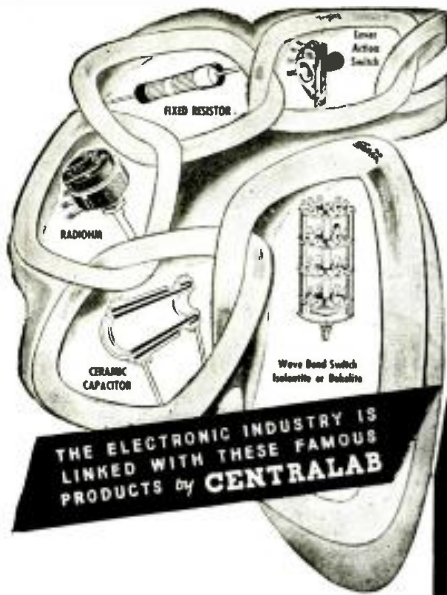

THE ELECTRONIC INDUSTRY IS LINKED WITH THESE FAMOUS PRODUCTS by **CENTRALAB**

Centralab plays an important part in the electronic industry . . . among set manufacturers—on the experimenter's bench—in the service man's kit and in ham shacks . . . for wherever **QUALITY, DEPENDABILITY, and RELIABILITY** count—Centralab serves supreme.

- LEVER ACTION SWITCHES
- FIXED RESISTORS
- RADIOHMS
- CERAMIC CAPACITORS
- WAVE BAND SWITCHES

# Centralab

DIV. OF GLOBE-UNION INC.  
900 E. Keefe Ave., Milwaukee, Wis.

Our Great, New 68-Page Book

**"CASH IN"**  
SHOWS 300 WAYS  
TO MAKE MONEY  
IN SPARE TIME!

Costs only 10c per copy

Book has 40,000 words in text  
SOLD ON A MONEY-BACK  
GUARANTEE! In "CASH IN"  
you get ALL the real money-  
makers—dozens of profitable  
tested mail-order plans, con-  
fidential business secrets,  
many practical tested  
formulas, successful  
tested schemes, tested  
money-makers, actual  
experiences of men  
who have started  
on a shoestring—  
with less than  
\$10 capital.

**CASH FOR YOUR SPARE TIME!**

BUYERS  
OF THIS  
BOOK TELL US

"Biggest value I've  
yet to see. Book is  
worth at least  
\$1.00."

J. SUDA, Brooklyn, N. Y.  
"Your book is as good,  
if not better, than others  
selling at \$1.00."

GEORGE BRUNET, Montreal, Can.  
"CASH IN is the best value  
I have yet to see in the mail  
order field."

LAWRENCE FOX, Brooklyn, N. Y.  
"CASH IN" contains only tested  
ideas covering every type of full-  
or part-time enterprise — IT'S A  
MASTER-GUIDE FOR SMALL BUSINESS  
VENTURES.

10c per copy. Sent POSTPAID copy  
where open receipts of 10  
cents in U.S. stamps or coin.

**NATIONAL PLANS INSTITUTE**  
246-R FIFTH AVENUE, NEW YORK, N. Y.

## RADIO ENGINEERING



RCA Institutes offer an intensive course of high standard embracing all phases of Radio and Television. Practical training with modern equipment at New York and Chicago schools. Also specialized courses and Home Study Courses under "No obligation" plan. Catalog Dept. RC-39.

**RCA INSTITUTES, Inc.**  
A Radio Corporation of America Service  
75 Varick St., New York 1154 Merchandise Mart, Chicago

der and lightning—would combine in one glorious extravaganza of sight and sound.

#### PROBLEM

Volume requirements for the musical reproduction were set by a number of factors. First, the location was outdoors, with the audience massed in a great circle at an average distance of 250 feet from the sound projectors. Second, the projectors were to be located at the very heart of the spectacle—amid 1,400 fountains hurtling 20 tons of water into the air at one time (and, at some of the fountains, 150 ft. high) . . . great jets of myriad-color flame, some 50 ft. high, consuming half-a-million cubic feet of gas per hour and hurrying at 150 jets with the roar of a thousand blast furnaces . . . intermittent percussions of aerial bombs and fireworks from 300 pre-set mortars.

Obviously, the quality of reproduction had to be of the highest, in keeping with the rest of the demonstration. This meant that every link of the "chain" from microphones to reproducers must be as flawless and perfectly coordinated as human ingenuity could possibly make them.

It was into such a maze of unusual problems that T. Frank Blutworth was drawn as chief consultant and later as planner and coordinator. Since the sound projectors and their driving units constituted the first and most pressing problem, several laboratories set to work in solving this. The system finally accepted was one developed in collaboration with Cinaudagraph engineers.

#### SOLUTION

The solution to the problem of reproduction was found to consist of 4 drum-like structures, resembling pillboxes, 24 feet in diameter and 7 feet in height. Into each of the drums 2 great horns were so fitted that they turned back within themselves, bringing their wedge-like apices back to the center of their mouths and thus conserving space. Each horn is so shaped that the sound is projected in a shallow layer of such pre-determined width that the combined area of coverage of all horns is a full 360 degrees, but with sufficient overlapping to permit the special "stereophonic" or *acoustic perspective* effect (which may be likened to the viewing of stereoscopic pictures—Editor).

This *stereophonic* or 3-dimension effect creates the illusion of "width," so that the sound seems to originate from points at left and right instead of merely from one point as in ordinary or 2-dimension reproduction (in which variation in volume tends to simulate "depth"). This effect is heightened, in this new sound system, by feeding left-hand sound reproducers with music from the left-hand side of the orchestra and the right-hand speakers with right-hand music, as will be described in more detail later on in this story. The "overlapping" mentioned above is the blending of these "left" and "right" divisions of the sound program.

The drums, or "igloos" as engineers at the Fair have dubbed them, must of necessity be located within the spectacle. This means, of course, that the loud-speaker units are operated in a constantly saturated atmosphere where at times tons of water pour over their housings, with great masses of spray actually blown into the horn openings. However, this was a relatively minor problem compared to the radical requirements demanded for frequency response, power handling ability and efficiency.

To meet these requirements, a specially-designed, 125-watt Cinaudagraph low-frequency or bass unit was combined with 2 (W.E.) high-frequency or treble units as

the driving equipment for each projector.

Some idea of the unusual features of the giant bass unit—largest in the world—may be obtained from the measurements. Its "pot" weighs just short of 500 pounds. Its diaphragm is 27 inches in diameter. Its voice coil is 6 inches in diameter! The unit is mounted inside the apex of the horn, thus providing reasonable protection from spray, since the diaphragm is facing to the rear, toward the hairpin bend of the horn and thus directly away from the opening.

This speaker unit is called upon to handle the frequency range from 28 cycles to middle C (256 cycles). Obviously, it would be quite impossible for a single unit to meet the requirements for efficient operation at 28 cycles, and at the same time provide effective response in the higher ranges. The higher register is taken care of by the pair of high-frequency units.

#### PROJECTOR PLACEMENT

The 2 projectors in each "igloo" are mounted side-by-side, their mouth openings constituting approximately 120 degrees of the circumference of the structure. The remaining two-thirds of the drums' interior is utilized for housing the relays and valves for the fountains, flame, jets, etc. All of this is remotely-controlled from switchboards in the main control tower, Building G-Q, some hundreds of feet distant from the lagoon.

The igloos are spaced to form the 4 corners of a rectangle 130 feet long by 60 feet wide. This set-up was planned without consulting sound engineers, however, and so at first appeared to involve a serious problem of phase relationship. But the unusual spacing was turned into a valuable asset through the simple expedient of designing the entire system to function in a stereophonic manner.

The drawing on page 143 illustrates how this was accomplished. It can be seen that the pickups are placed at each side of the "bend" (the sound system being designed primarily for reproduction of band music), and the amplifier and sound channels associated with each microphone are kept separate throughout, each terminating in projector units diagonally opposite one another. (Each output transformer, incidentally, weighs 100 lbs.; the amplifiers employ 2



A portion of the amplifying equipment used in the super-power, 3-dimension sound system at the Lagoon of Nations, New York World's Fair, 1939. Frequency range: 28 to 11,000 cycles!

Please Say That You Saw It in RADIO-CRAFT



tubes per stage in a balanced, resistance-capacity coupled circuit.—*Editor*) Thus listeners, standing at any positions in the vicinity of points (1) or (2) will hear the reproduction in its original perspective. From the projectors to their immediate right will emerge predominately the "instrument" located in the right-half of the band, while those at the left will be heard principally through the projector at the left. Thus a highly effective and natural stereophonic effect is produced.

Listeners in the general vicinity of positions (3) and (4) will, of course, observe this same effect, but with the instrument positions transposed. Within limits the effect varies as the listener moves away from any of the 4 positions shown in the diagram. This would be just as true, however, were a person, listening to the band directly, to move to one side of the studio. It is believed that this is the first sound installation to attempt such an effect out-of-doors and over an entire projected area encompassing the 360 degrees of a complete circle.

(It may be of interest to *Radio-Craft* readers to know that every program is different; even when a second cycle of programs is put on, each program is only similar, not identical, to its presentation in the preceding cycle. Each program is recorded and the phono disc then is used as a reference during rehearsals. The 38-piece "live" orchestra—the World's Fair's "Tritons"—and the recorder, are located in Building 0-6; while in Building G-Q operators in front of yard-long cue sheets or "scores" that unwind from one roll onto another, manipulate controls in accordance with these cues, which are timed to the second.—*Editor*)

There are 76 other Cinaudagraph installations at the Fair, employing some 1,800 speakers. These range from tiny 6-in. dynamics to the mighty 27-in. units specially constructed for the Lagoon of Nations.

### NEW CIRCUITS IN MODERN RADIO RECEIVERS

(Continued from page 151)

nance of oscillation.

For the high-frequency bands, note that small resistors are placed in series with the trimmers, which approximate the radio frequency coil resistances and hence tend to maintain the best phase relations between the grid and cathode. They also make adjustment of these trimmers less critical.

#### (4) PORTABLE RECEIVER COMBINES HIGH SENSITIVITY WITH GOOD FIDELITY

Emerson Model CT-275. *New in a portable circuit, this receiver uses resistance-capacity coupling between the 1st and 2nd I.F. stages.*

Tuning of the input loop used with this set is somewhat sharper than for an ordinary circuit and if the I.F. were entirely coupled with resonance transformers, there would be 6 tuned I.F. circuits, which would make the entire tuning much too sharp for high-fidelity reception.

However, the additional I.F. stage provides the desirable added sensitivity. Thus, the best compromise was to couple the 2 I.F. amplifiers with an untuned coupling system as in Fig. 2A.

#### (5) PUSHBUTTON OPERATION FOR SIMPLE T.R.F. SET

Sears, Roebuck & Co. Model 7219. *An R.F. and a detector metal-core transformer*

(Continued on page 182)

# RIMCO DYNALYZER

MODEL 701

THE FIRST COMPLETE DYNAMIC TESTER

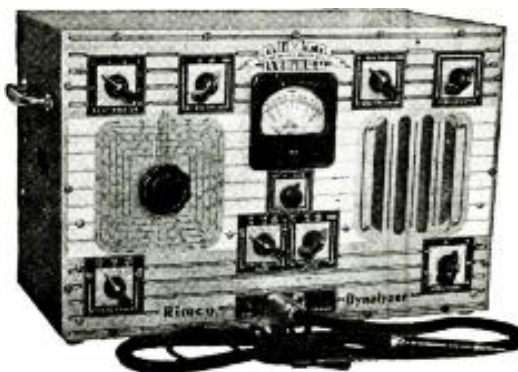

*It's New!*

*Built in DYNAMIC SPEAKER*

*Mail Today!*

**B**UILT in DYNAMIC SPEAKER for audible tests of distortion, hum and noises in any stage • Illuminated meter for R-F, I-F, and A-F gain comparisons per stage • Measurements of actual operating voltages without reversal of leads • Checks control voltages developed by the signal and present at the tube elements, A.V.C. and A.F.C.—and resistances from 1 ohm to 10 megohms • Tunes in, demodulates and amplifies broadcast signals for AUDIO test purposes • Provisions for connecting oscilloscope when desired.

Accurately checks all frequencies from 95 Kc. to 15 Mc. • Does not have unnecessary gadgets or functions to complicate operation • Designed for maximum simplicity, speed and usefulness • Write TODAY for descriptive literature.

Radio Instruments Manufacturing Co.,  
625 West Monument Street,  
Jackson, Mississippi, U.S.A.

Please send me complete information on the new RIMCO DYNALYZER, Model 701.

Name .....

Address .....

City .....

State .....

*Mail Today!*

### YOUR LAST OPPORTUNITY TO GET THIS FREE BOOK!

Only a few copies of the RADIO REFERENCE ANNUAL are still available! It's the BIG, FREE BOOK of 64-pages you receive when you subscribe to RADIO-CRAFT. The ANNUAL covers set building, servicing, public address, test equipment, plus a number of other interesting topics. Send your remittance of One Dollar to RADIO-CRAFT, 99-R HUDSON STREET, New York, N. Y., and you will receive a subscription to RADIO-CRAFT for Seven Months, and your copy of the RADIO REFERENCE ANNUAL will be mailed postpaid immediately.

### WE BUY FOR CASH

*In any quantity*  
**USED CLASSICAL PHONOGRAPH RECORDS**  
— REGARDLESS HOW OLD —  
MAIL US LIST OF ARTISTS & SELECTIONS  
HIGHEST PRICES PAID  
**MODELL'S — DEPT. R-9**  
58 CORTLANDT ST., New York, N. Y.

### CHUNG YUEN ELECTRICAL CO.

71 Des Voeux Road, Central HONG KONG, CHINA  
Largest wholesalers and retailers in southern China. Outlets in all important cities. Complete line of radio, household, motor, factory, public utility, etc. parts and supplies. Manufacturers invited to submit their catalogs and description of products for consideration. Extensive sales facilities and staff available to handle additional products for Eastern trade.

Please Say That You Saw It in RADIO-CRAFT

## SERVICING TELEVISION RECEIVER FAULTS

(Continued from page 149)

Laugh at Temperature and Climate

with the **TURNER "99"**

### DYNAMIC MICROPHONE

For Indoors or Out

Takes abuse like a pugilist. Not sensitive to mechanical shock, or affected by dampness or salt air. Gives crisp reproduction with no low frequency boom. Trusty response range, 40-9000 cycles. High level 54 Db. Cable connector, for quick, easy cable change. Adjustable saddle for any standard stand. Available in all impedances.



**\$29.50** List  
HIGH IMPEDANCE

MODEL 99 LOOKS EXPENSIVE—YET COSTS LITTLE

Write Now For Full Details

**The TURNER CO.**

CEDAR RAPIDS, IOWA, U. S. A.

Finished in rich, durable Runmetal. Decidedly semi-directional, reducing feed-back problems. Professional appearance. 25 ft. cable included.

### PATENTS—TRADE MARKS

Booklet concerning Inventions & Patents Form "Evidences of Conception" with instructions for use and "Schedule of Government and Attorneys Fees"—Free

**LANCASTER, ALLWINE & ROMMEL**

Registered Patent Attorneys

436 Bowen Bldg. Washington, D. C.

**EVERYTHING IN RADIO!**

A COMPLETE SOURCE FOR YOUR RADIO NEEDS

Our immense stock of radio sets, parts and supplies enables you to purchase your entire needs on one order. You will find all your Nationally Known Favorites in this big book which is FREE for the asking. Practically every order is shipped the same day it is received. WRITE FOR BIG NEW CATALOG

**BURSTEIN-APPLEBEE CO.**  
1072-14 McDow St. - Kansas City, Mo.

### "R. M. S. SUPER" COMPACTS

Exclusive Radios for the Serviceman

Low list prices—Big Discounts  
Also PHILCO PARTS and TUBES

Send 10c in stamps for "R.M.S. SUPER" broadside. PHILCO Parts Catalogue and Wholesale Prices.

**WILLIAMS PHILCO CO.**

802 S. Adams St. Peoria, Ill.

**FREE AMPLITONE**

**New 1939 Sound Catalog**

Illustrating our complete line of modern sound equipment.

Write for your FREE copy NOW!

**AMPLITONE PRODUCTS CO.**  
135 Liberty St. New York City, N. Y.

### Television

ARE YOU prepared to take advantage of the opportunities that the new TELEVISION industry is creating? Train yourself now, while Television is young, for a better job. Write for FREE ILLUSTRATED BROCHURE, "A Tested Plan for a Future in Radio & Television." CAPITOL RADIO ENGINEERING INSTITUTE, Dept. RC-9, 3221-16th St., N.W., Washington, D. C.

**ELECTRICITY** FROM YOUR OWN ELECTRIC PLANT WHEN POWER LINES FAIL

ONAN A.C. ELECTRIC PLANTS supply current for Radios, Transmitters and Receivers, P. A. Systems, Movie Projectors, Sound Truck Apparatus, Tools, Lights, All Appliances. Used as Standby Equipment in Schools, Hospitals, Theatres and Public Buildings in case of Power Line Failure due to Storms, Floods, etc. Available in 110 or 220 Volt A.C.—12, 32 and 110 Volt D.C.—Also Dual Voltage A.C.-D.C. Types. Manual, Full-Automatic & Self-Starting. \$99 and up. Shipped, Ready to Run.

**D. W. ONAN & SONS**  
686 Exposition Avenue Minneapolis, Minn.

### GET A REAL ELECTROPLATING KIT ABSOLUTELY FREE!

Complete details as to how it is possible to get a Real Electroplating Kit FREE, appear on Page 180 of this issue. TURN TO IT NOW!

regard to the oscillator frequency, harmonics of which usually extend liberally and can thus well occur around 45 mc. For instance, take a flagrant example. If a sound I.F. of 3.5 mc. is chosen and the sum frequency is employed for the oscillator, i.e., 41.5 plus 3.5 mc., this will be 45 mc. and severe interference with the vision circuits will almost certainly be experienced.

The only likely remaining external source of these forms of interference will be that due to second-channel interference from any stations that may be operating at suitable frequencies. In this event care in the choice of the oscillator frequency is desirable unless the selectivity of the signal frequency circuits is adequate. For example assuming the very suitable, and for this reason widely employed, I.F. of 13 mc. has been chosen, then it is preferable, indeed one can say it is essential, to employ the sum oscillator frequency, that is (45 plus 13 mc.) second-channel interference then is only possible from a band approximately 4 mc. wide centered upon 58 plus 13, that is 71 mc. Presumably there are no stations operating in this band.

On the other hand, if the difference frequency had been chosen, that is 32 mc. (45 - 13 = 32 mc.) second-channel interference occurs over a band centered upon 19 mc. (32 - 13 = 19 mc.). It is well known there are a great number of stations located in this band (in England—Ed.), consequently interference is almost bound to occur.

For various reasons 13 mc., as has already been mentioned, is an excellent compromise. It must not be expected that all troubles are avoided by the simple expedient of correctly choosing the I.F. In addition adequate shielding of the I.F. and signal frequency circuits is required; incidentally, this shielding of the I.F. circuits must also be adequate to prevent direct I.F. pick-up of stations operating in the I.F. pass band.

### FREQUENCY FILTERS

A considerable improvement is also effected with the inclusion of a detector filter which also will have a marked effect in improving the overall stability of the receiver. Quite a simple type will in most cases suffice and this can be arranged as shown in Fig. 6.

The inductances L are each comprised of 138 turns of No. 38 D.S.C. wire close-wound on 1/2-in. forms. Condenser C is 10 mmfs., and C1, 20 mmfs. The resistance, R, may have a value of 3,500 to 5,000 ohms. The inductances are mounted at right-angles to each other and it is convenient to assemble these items in a common shield can.

An alternative filter arrangement can be employed. In this, compensation for losses due to the circuit and interelectrode capacity are made by including a series peaking inductance in the load. In addition a filter inductance is included, the complete arrangement then attenuating rapidly above the highest desired modulation frequency. Figure 8 shows one arrangement on these lines, the constants, however, depend largely upon the associated circuit conditions and a full treatment is outside the scope of the present series.

Actually the above remarks, strictly speaking, are true for any filter arrangement. That is to say the various constants ordinarily are determined in accordance with conventional filter theory but, the arrangement of Fig. 6 is applicable in most cases and serves its purpose satisfactorily.

### INTERFERENCE

It is somewhat difficult to describe categorically or to provide photographs which will adequately convey the various forms of these interferences. If, however, interference which can manifest itself as wavy patterns, as diagonal lines or as small striations or spots in the image is experienced then it is safe to assume the effect is attributable to one of the above causes. The effects are generally variations in lesser degree of that depicted in Fig. 7. One point requires mention. Interference due to diathermy apparatus results in somewhat similar effects, but it is not difficult, because of the intermittent nature of this form of interference, to determine whether this actually is so.

With the question of the production of avoidable interference cleared up attention can be directed to the requirements of frequency response for the complete vision unit. In general two main sections of the unit are involved, namely, the I.F. amplifying stages and the vision-frequency (V.F.) stage or stages. It is the horizontal definition in the image with which we have to concern ourselves, for definition in the vertical direction is governed only by the line frequency (10,125 c.p.s.). With an image ratio of 5:4 it is easily seen that for equal horizontal definition, frequencies of the order of  $10^6 \times 2 \times 1.25$  mc., i.e., 2.5 mc. are involved. Actually somewhat less, as some portion of the image necessarily is taken up for synchronizing purposes.

At the extreme low frequencies good response down to 50 c.p.s. (i.e., the frame frequency) is adequate, especially as the response to D.C. level changes can be artificially invoked. It is apparent, therefore, that the requirement for first-class image definition is a substantially linear response for the vision channel over the band extending from 50 c.p.s. to 2.5 mc.p.s. The phase shift throughout this band must also be substantially constant although some degree of lag at the very high frequencies is permissible and is indeed not easily avoided. In general, the question of phase shift is a matter of adequate frequency response.

### FREQUENCY REQUIREMENTS

Dealing first with the low-frequency requirements. The effect in the image with inadequate response in this region is an apparent variation of brightness in the vertical direction. A D.C. correction or a D.C. restoring device will not necessarily remove this fault, though this will depend upon the time constant of the restoring device. The correct procedure is to improve the L.F. response. Where a coupling condenser and leak are employed between the V.F. stages or to the grid of the C.-R. tube an increase in their time constant will improve matters, that is to say, the value of the condenser or of the leak is to be increased.

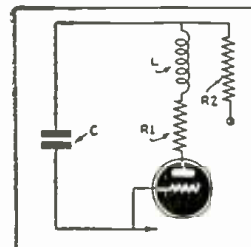

Fig. 9. An easily-incorporated form of bass-boosting circuit. This arrangement also increases the circuit filtering.

An alternative and preferable plan is to employ some form of low-frequency correction which may well be an arrangement on the lines of that shown by Fig. 9. Here an additional load resistance R2 and its associated bypass condenser C increase the

Please Say That You Saw It in RADIO-CRAFT



response at the lower frequencies. It is obvious that with C possessing a fairly high reactance at low frequencies the additional load resistance R2 increases the plate load at these frequencies thereby increasing the gain; whereas, at progressively higher frequencies the reactance of C decreases, reducing the effect of R2. The circuit constants (i.e., the true load resistance R and the series peaking inductance L) are chosen without regard to these additional components (R2 and C) for these are only operative at the low frequencies, moreover the overall stage gain is not affected for there is a boost at low frequencies, the levelling effect not being obtained with attenuation at high frequencies. Suitable values for R2 and C are 3,000 ohms and 10 to 16 mf., respectively.

It is desirable to interpolate a caution regarding the diagnosing of this fault. Similar shading effects occur due to (a) non-linearity of scan in the vertical deflecting circuits (This point has already received attention in this series.); and, (b) presence of hum in the modulation output. This latter effect is usually manifest as a dark horizontal band across the picture. It is usually possible to ascertain whether this is the case by operating the equipment with no signal applied at the aerial terminals when this dark band will be observed passing vertically across the screen.

The photograph, Fig. 10, shows the shading effect described above. It is seen that the lower half of the image is rendered at a greater illumination intensity than is that of the upper portion.

Figure 11 depicts the effect obtaining when hum is present. In this photograph the hum band appears at the center of the image but this is not necessarily always so. Its actual position is determined by the relationship existing between the phase of the receiver and of the transmitter, power-supply line.

In the concluding article of this series the upper frequency response requirements and phase distortion in the I.F. and the V.F. circuits will be dealt with.

(To be continued.)

**SERVICEMEN —**

You can build a practical, low-cost Frequency Modulator (wobbler) from "junk box" parts. Complete construction details and diagrams are given in the October Issue of Radio-Craft.

**OPERATING NOTES**

(Continued from page 169)

ets have internal ground connections. If this is not known, the wiring may seem incomplete. The internal socket connections are: one heater, the cathode, and the shield are grounded to a common grounding lug located on the side of the socket.

**POOR PHONOGRAPH REPRODUCTION**

This model receiver uses the latest type of crystal phonograph pickup and therefore is capable of giving excellent reproduction. Poor tone quality on phonograph operation may be due to the use of worn needles or records. Be sure to use a good record and change the needle as often as required to secure good tone.

**CIRCUIT FEATURES**

The triode section of the 6Q7G tube utilizes a circuit arrangement which gives a minimum of distortion and excellent gain with zero bias on the grid. At high signal levels, this circuit gives less distortion than if the tube is operated with a fixed bias.



*Fast and Convenient!*

**CORNELL-DUBILIER'S**  
*New*  
**CAPACITOR**  
*Analyzer*

**MEASURES CAPACITY.** Measures capacity of paper, mica, air, electrolytic and motor starting capacitors from .00001 to 240 mfd.  
**MEASURES POWER FACTOR.** Measures power factor from 0 to 50% on all types of electrolytics including motor starting types.  
**INDICATES INSULATION RESISTANCE.** Measures insulation resistance of paper and mica capacitors.  
**INDICATES LEAKAGE.** Measures leakage of electrolytics by means of built-in D.C. power supply.  
**VISUAL EYE LEAKAGE INDICATOR.** Provides leakage tests on all types of capacitors.  
**HIGH SENSITIVITY.** Amplifier for capacity, power factor and leakage tests provides sharp and accurate readings. AMPLIFIER BUILT IN ANALYZER.  
**DIRECT READING LINEAR SCALE CALIBRATIONS.** All scales uniformly spaced.  
**PUSH BUTTON SWITCHING.** All test changes made by push button switches.  
**SIX COLOR CODED SCALES.** Uniformly spaced over total spacing of 60 inches. No "blind spots".  
**SELF CONTAINED . . . PORTABLE.** Complete in itself, requiring no external equipment. A portable unit for 110 V. 50-60 cycle operation, in walnut cabinet with removable cover and carrying handle.

Check this new CAPACITOR ANALYZER, feature for feature with your idea of the perfect capacitor test instrument. See if you don't agree when we say, "No up-to-date service shop ought to be without it".

For here's the Analyzer that has everything. It's fast and convenient. It reduces time in servicing. Servicemen who have used the C-D Analyzer say they wouldn't sell it for twice its value. You'll say it's the finest instrument you've ever used. Check up. Mail the coupon today for Catalog No. 167-A and the complete C-D Analyzer story. Model BF-50 Capacitor Analyzer, Dealer Net **\$24<sup>90</sup>**  
Price .. (less tubes) .....

PRODUCT OF THE  
WORLD'S LARGEST  
MANUFACTURER  
OF CAPACITORS

TEAR OFF AND  
MAIL COUPON

**CORNELL-DUBILIER**  
**ELECTRIC CORPORATION**  
1014 Hamilton Boulevard, South Plainfield, New Jersey  
Cable Address: COREU

CORNELL-DUBILIER ELECTRIC CORPORATION. RC939  
SOUTH PLAINFIELD, NEW JERSEY

Please rush to me the following catalog material.

Catalog No. 167A on Capacitor Instruments.  
 Catalog No. 161A on complete line of C-D capacitors.  
 Catalog No. 164A on Quietest Interference Filters.  
 Place me on your mailing list for Free C-D House Organ.

Name \_\_\_\_\_  
Address \_\_\_\_\_  
City \_\_\_\_\_ State \_\_\_\_\_

The proper operation of this circuit depends largely on the high resistance of the grid resistor. This resistor is rated at 10 megohms. Do not substitute any lower value since this would increase distortion and decrease amplification.

STEWART-WARNER CORPORATION,  
J. N. Golten,  
Service Department.

**ZENITH MODEL 4-F-133**

This set, or receivers with similar type tubes (1C7G, 1D5G, 1F7G, and 1F5G), can be very economically converted for new 1.5-volt operation where they were formally operated on 2 volts or even on 6 volts by eliminating the vibrator pack.

The only changes necessary are the addition of an 800-ohm resistor in the "B-" lead, connecting this resistor from "C-" lead to chassis and using "C-" for "B-".

The load resistor for the plate of the 1F7G is sufficient for the 1H5G, but the screen-grid resistor (1 meg.) can be used if desired.

The new tube complement consists of the following: 1A7G, 1N5G, 1H5G, and 1A5G, drawing only 200 ma. filament and 8 ma. plate current. The saving in battery consumption more than offsets the first cost of tubes, etc.

The set must be re-aligned after the change.

J. E. THOMSON.

Please Say That You Saw It in RADIO-CRAFT

**FREE TRIAL OFFER**

**NEW REMINGTON NOISELESS PORTABLE!**  
AS LITTLE AS



**10¢ A DAY**

Famous Remington Noiseless Portable that speaks in a whisper. Pay as little as 10¢ a day. Guaranteed by the factory. Standard keyboard. Automatic ribbon reverse. Variable line spacer and all the conveniences of the finest portable ever built. PLUS the NOISELESS feature. Act now. Send coupon TODAY for details.

**You don't RISK a Penny**

We send you Remington Noiseless Portable for 10 days' free trial. If not satisfied, send it back. We pay all shipping charges.

**Typing Course and Carrying Case**

You will receive FREE a complete simplified home course in Touch Typing, a handsome sturdy carrying case is included. No obligation. Mail coupon for full details—NOW.

Remington Rand, Inc., Dept. 189-9,  
465 Washington St., Buffalo, N. Y.

Tell me, without obligation, how to get a Free Trial of a new Remington Noiseless Portable, including Carrying Case and Free Typing Course for as little as 10¢ a day. Send Catalogue.

Name \_\_\_\_\_  
Address \_\_\_\_\_  
City \_\_\_\_\_ State \_\_\_\_\_





**Frame Frequency.** This control must be adjusted to give 60-cycle sawtooth wave.

**Frame Hold.** The intensity of synch. pulses to the grid of the type 885 Vertical sweep oscillator is controlled here.

**Intensity.** This control (on the oscilloscope) adjusts the image brilliance and should be set so that the screen on the end of the C-R. tube is almost dark when modulation is off.

**Focus.** This control (on the oscilloscope) should be set while viewing a test pattern to the point of maximum readability.

**Centering.** Here's a third control (2, on oscilloscope); it should be set so that the raster is centered.

**Size.** This control (2, on oscilloscope) should be set to give an image of the proper (4 to 3) "aspect ratio" (viewing proportion) whose corners just touch the edges of the circle of the fluorescent screen.

**Line Frequency.** The 5th control (on the oscilloscope) is adjusted until the modulation streaks on the screen "flop" 90 degrees and form an image.

**Line Hold.** Set this control (on the oscilloscope) to the most stable point. The 885 used in the line sweep circuit must be carefully selected. Some 885-type tubes have both a fluctuating ignition voltage and de-ionization time, and will not hold.

**Tuning-In.** Make use of the test chart which is transmitted steadily for 1 hour before each scheduled telecast. Turn the outfit on. Advance the R.F. gain controls to just below the point of oscillation for the received signal strength. Trim until modulation streaks appear on the screen.

Adjust Clipper, Horizontal and Vertical Hold to the point just before they start to affect image size. Adjust Centering and Size controls. Adjust the Frame Frequency until frames are observed and brought to a stop. Adjust Line Frequency until the horizontal streaks which appear on the window flop over and an image appears. Adjust Focus, Brilliance, and Contrast to suit.

**Sound.** The sound which accompanies the telly image may be received on any radio set which tunes-in, directly or indirectly the 49.75 mc. sound carrier. An ordinary broadcast receiver may be used with an ultra-highfrequency converter such as the Detrola "Pee Wee" model 280 (shown in photo) this converter fed telly-sound into an ordinary battery-portable! A converter may be built which consists of a mixer and oscillator to convert the incoming waves to an intermediate frequency in the tuning range of the broadcast set.

The converter makes reception possible

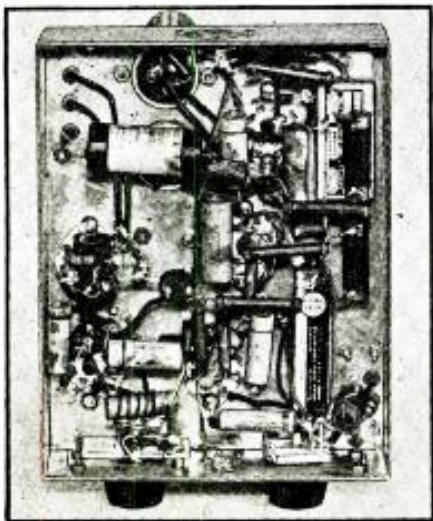

Under-chassis view of the video-signal tuner.



"Fine! Then keep it up-to-date by adding the 1938-39 Supplement!"

## SYLVANIA

Set-Tested Radio Tubes

Also Makers of Hygrade Lamp Bulbs

on the broadcast set by the superheterodyne principle; it connects to the B.C. set's antenna and ground posts. An adapter may be used instead; it connects, inside the set, to the A.F. section of any B.C. receiver.

The author wishes to acknowledge the able assistance of Jerrier Haddad who did the construction work on the video receiver. Jerrier is a Senior at Brooklyn Technical High School (N. Y. C.).

### LIST OF PARTS

#### CONDENSERS

- One Hammarlund variable condenser, type HF-15, 15 mmf., C1;
- Two Hammarlund variable condensers, type HF-35, 30 mmf., C2, C3;
- Four Cornell-Dubilier paper condensers, type DT-451, 0.01-mf., 400 V., C4, C5, C8, C10;
- Two Cornell-Dubilier paper condensers, type DT-6T5, 500 mmf., 400 V., C7, C11;
- Two Cornell-Dubilier paper condensers, type DT-4S5, 0.05-mf., 400 V., C6; C9;
- One Cornell-Dubilier mica condenser, type 3L-5Q2, 20 mmf., 400 V., C12;
- Two Solar electrolytic condensers, type LG5-8, 8 mf., 450 V., C13, C17;
- Two Solar electrolytic condensers, type 66730-PEP, 350 mf., 25-50 V., C14, C18;
- Four Cornell-Dubilier paper condensers, type DT-4P1, 0.1-mf., 400 V., C15, C16, C19, C20;
- One Solar electrolytic condenser, type LG5-16, 16 mf., 450 V., C21;
- One Cornell-Dubilier condenser, type 3L-5Q4, 40 mmf., 500 V., C22;

#### RESISTORS

- Three I.R.C. resistors, type BT 1/2, 160 ohms, 1/2-W., R1, R11, R16;
- One Centralab potentiometer, 50,000 ohms, R2;

(Continued on page 182)

## WHICH DO YOU NEED?

If you haven't the regular Complement Book, send for No. 1. All the contents of Sylvania's standard Tube Complement Book—plus a big, complete 56-page Supplement giving the tube complements and if peaks of all the new, recently-announced sets—bound right into the center of the regular book! 221 pages, all told . . . and it's yours for only 25c.

Or—if you already own a Sylvania Tube Complement Book—just send for No. 2. The 1938-39 Supplement will bring it completely up-to-date—and thus improve your servicing on new sets. The Supplement is 10c.

### RUSH THIS COUPON!

Dept. C, Hygrade Sylvania Corp. (No. 1) Emporium, Pa.

Please send me the Complement Book, complete with 1938-39 Supplement @ 25c.

Send me the 1938-39 Supplement @ (No. 2) 10c.

Name .....

Address .....

City ..... State .....

Name of Jobber .....

## Radio Men find This Book Handy

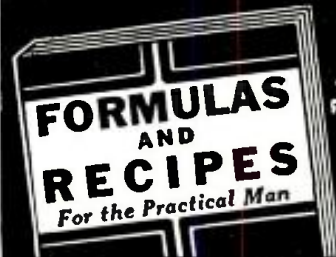

50¢ POSTPAID

### Here Is the Contents of the Book

- 1 Adhesives: Glues, Cements, Gums, Mucicases, Lubricants
- 2 Cleansing: Stain Removers, Laid Removers, Bleaches, Cleaning Fluids
- 3 Metal Craft: Coloring, Oxidizing, Plating, Re-plating, Welding, Polishes, Alloys, Solders, Amalgams
- 4 Paints: Colors, Stains, Varnishes, Enamels, Luminous Paint, Washable Paint, Paint-Removing, Waterproofing, Fireproofing
- 5 Glass-Working: Cutting, Drilling, Boring, Bending, Blowing, Etching, Engraving, Frosting, Silvering, etc.
- 6 Wool-eralt: Fillers, Fireproofing, Acid-proofing, Waterproofing, Furniture Polishes, Finishes, etc.
- 7 Ink Recipes, Eradicators, Ink Stain Removers, Special Inks, Colored, In-gelible, Sympathetic, Invisible, Hectograph
- 8 Photography: Developers, Emulsions, Fixers, Sensitizing, Toning, Printing, Photographic Paper, Blueprint Paper
- 9 Antidotes for Poisons, Remedies for Burns and Scalds, Disinfectants, First-Aid in Accidents, Emergency Remedies, Home Remedies
- 10 Preparation, Manipulation, Handling, Mixing, Measuring, Weighing, Filtering, Straining Solutions; List of Technical Substances; Emulsifying; Use of Hydrometer; Use of Thermometer; Tables of Weights and Measures, Decimal Systems, Useful Tables

**TECHNIFAX, Division RC-939**  
1915 So. State Street, Chicago, Illinois

TECHNIFAX, Division RC-939  
1915 So. State Street, Chicago, Illinois

Gentlemen: Enclosed please find 50c (check, money order, coin or unused U.S. stamps accepted) for which send me POSTAGE PREPAID. One Copy of FORMULAS AND RECIPES For the Practical Man.

Name .....

Address .....

City ..... State .....

Please Say That You Saw It in RADIO-CRAFT



# NEW!

A NEW GERNSBACK PUBLICATION  
The Constructive Photo Magazine



ON ALL NEWSSTANDS

FOR serious-minded amateur photographers, here's a photo magazine, FOTO-CRAFT, vastly different from any you've read. It tells you how and why to do things—it's a constructive publication which shows what can be done with the equipment you have, and how to make handy, photographic accessories. FOTO-CRAFT, with its broad editorial features, covers such important branches of photography as—New Scientific Researches; Developing; Printing; Enlarging; Insulating; Cropping; Photomicrography; Color Photography; Amateur Movies; How to Make It Items

A Few of the Articles in the Current Issue:  
Let's Get Together—Control Printing—Making Rain and Dew for Photos—Quick Changing Bags—Improved Darkrooms—Nifty Tricks—Projection Screen—Avoiding Disappointment—Make This Camera Carrying Case—Home-Made Drying Cabinet—Tilt-Top Is Easy to Make—Bizarre Photos—Become Color Conscious—Home-made Enlarger Built into Closet—Mirror Stuff—Paper Negatives Ideal for Copying—Visible Enlarging—Photographic Tattlers—Portable Screen—Photo Hints & Kinks—Photo Decoupage—And Another Free Gift—Fur Lens Cleaner.

**BIG OPPORTUNITY!** Get a FOTO-CRAFT Press Card today—with it you can get permission to take photos which might be difficult to obtain. PRESS CARDS are sent FREE to subscribers of FOTO-CRAFT. Enter your subscription for Seven Months for \$1.00—and get your PRESS CARD immediately.

## FOTO-CRAFT

99-R HUDSON STREET NEW YORK, N. Y.

Short-Wave fans need this  
**WORLD-TIME CLOCK**  
The Only Clock for Universal Use  
Throughout the Entire World!



**A REGULAR CLOCK**  
with A.M. and P.M. divided dial

**A WORLD-TIME CLOCK**  
Instantly indicating time in all 24 zones

**INTERNATIONAL CLOCK**  
with A.M. and P.M. 24 hour dial

Here is really the first new clock advancement in 200 years—three clocks in one, a world-time clock. It is revolutionary! It is years ahead! The Sky Pilot **WORLD-TIME CLOCK** is the only clock designed for use anywhere in the world. For short-wave fans this clock offers great convenience—it is educational and at the same time indicates world time differences. In a few seconds you can determine the correct time in London, Moscow, Hawaii, Tokyo, Buenos Aires, Halifax—anywhere. American made—it is exceptionally easy to operate. It carries a guarantee of ninety days against defects in material or workmanship. In modernistic design, it is made of brushed brass—measures 5 1/4" high by 4 3/4" wide—and has convex crystal. Spring driven model ..... **\$4.95**

Electric driven (for A. C. 110-120 volts, 60 cycles) ..... **\$5.95**  
Remit by check or money order; register letter if you send cash or unused U.S. postage stamps. Add 25c to cover postage and insurance in U.S.A., Canadian and foreign add 35c.

### RADIO AND TELEVISION Magazine

99-R HUDSON STREET NEW YORK, N. Y.

## RADIO COURSES

New Fall Classes Start in September  
RADIO OPERATING—BROADCASTING

- RADIO SERVICING — a practical course
- RADIO AMATEUR CODE ● TELEVISION
- ELECTRONICS—1 yr. day course 2 yrs. eve.

Day and Evening Classes. Booklet Upon Request.  
**New York Y.M.C.A. Schools**  
6 W. 64th Street New York City

## GETTING INTO TELEVISION SERVICING

(Continued from page 159)

least 10 feet high and must be fastened very rigidly to the building masonry by means of strap iron brackets and anchor bolts. A "star" drill is used to bore a hole in brick or concrete, deep enough to receive the female end of the anchor bolt. See Fig. 1A for a typical installation.

To make the dipole more directive whenever required it is expedient to mount a duplicate set of dipole rods 1/4-wavelength apart from the receiving dipole as shown in Fig. 1B. It may be necessary in some cases to mount the dipole rods vertically instead of horizontally. In all cases the transmission line should be spaced away from the wall at least 6 inches all the way down to the apartment. The receiver itself should be located as favorably as possible in the room. In view of the exacting work, expensive material and physical hazard involved in the installation, a charge of \$20 or \$25 (including material) would be considered fair recompense.

### TEST EQUIPMENT

For the average shop, the test equipment will also include a square-wave generator, a good 3- or 5-inch 'scope, a "picture signal" generator, a dependable oscillator such as used for aligning all-wave receivers, and a V-T.V.M. or output meter. Of course, you may get by without most of this equipment for a while but eventually you will need each piece. For the few who can afford it there is already available precision equipment such as the special Cathode-Ray Oscillograph and Video Sweep Oscillator made by RCA.

One thing we must learn is to work with caution—aside from the personal safety angle—we must learn not to poke around aimlessly among the critical high-frequency circuits of a television set. You can do horrible things to the image just by pulling wires out of original lead-dress. Also, having been accustomed to deal with undistorted sine-wave audio frequencies in testing sound receivers, we now must learn to handle distorted (square-wave) frequencies for testing sight receivers.

The old reliable 1,000 ohms-per-volt tester with ranges up to 1,000 volts is definitely "out" for television service. In the first place the highest voltages on some of the larger sets may reach at least 7,000 volts and in the second place, the 1 milliamper current required (for the meter at full-scale) would constitute almost the entire output of the high-voltage supply, thus giving rise to errors in meter reading exceeding 50 per cent.; so your television voltmeter must be of 20,000 or better yet, 25,000 ohms/volt sensitivity and have a top range of at least 5,000 volts.

Use only highly-insulated test probes and leads and (remember this one!) keep one hand in your pocket, when checking high voltages. Always be certain there is a good ground connection to the set chassis, for safety's sake.

### TELEVISION COMPONENTS

As previously mentioned, each component part must be built to withstand much higher voltages than heretofore used, necessitating a higher safety factor and very close tolerance limits. High-voltage condensers, for example, are of highest grade paper and foil, impregnated with non-explosive oil and housed in shock-proof containers. Dry electrolytics of improved type are used in large numbers for the low-voltage circuits, where low power factor and low current leakage are requisites.

As for resistors, the metallized bakelite-insulated type predominates. Wire-wound

resistors are used only where their self-inductance does no harm, as in the power supply. Even so, the metallized type has some inductance at frequencies above 50 megacycles and whenever you have occasion to replace a resistor in these ultra-high-frequency circuits you not only must use the exact original value but also mount the resistor in its exact original location with respect to the chassis and other parts. You may note that the potentiometers used in the high-voltage supply are of the ordinary low-watts carbon type. These "pots." carry very little current and very high voltages, therefore, to prevent arcing between the pot. shaft and chassis, the pot. is mounted on a bakelite strip which in turn is spaced away from the chassis.

Similarly you will find high-voltage sockets spaced away from the chassis for the same reason. In sight and sound receivers, special precautions are taken to eliminate microphonics by rubber-cushioning the chassis, the speaker, detector socket and image tube.

Everything possible is being done to insure the safety of owner, Serviceman and apparatus. For example, high-voltage top caps on rectifier tubes are fitted with large insulated cups. Safety switches are built-in to the cabinet and chassis, opening the power line and discharging the high-voltage condensers to ground, when the back cover is removed.

An important contribution to safety is the 1-milliamper fuse recently announced (Continued on opposite page)

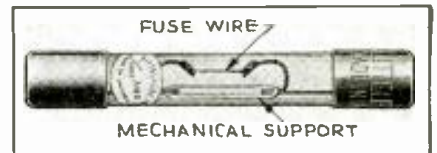

Here's a double-duty fuse which both protects television equipment, and protects human beings from the lethal potentialities of this equipment. This Littelfuse is available in sizes from 1 ma. to 1/16-A., in up to 20,000-volt circuits.



This type XAT-2 condenser is 1 of 3 television types in Solar's new line of oil-impregnated, oil-filled units, for use on circuits up to 7,500 V., D.C. Both leads are brought to terminals to permit grounding the can.

In an article condensed from *The Scientific Worker* (London), and appearing in last month's issue of *World Digest of Current Fact and Comment* in "Television Triumphs," A. N. May interestingly analyzes the development of electronic television.

In 2 issues of *World Radio* (London), last month, "Television Transmission by Telephone Cable" described B.B.C.'s success with television transmissions over telephone lines, at 405-line fidelity, at distances up to about 5 miles. This of course beats the distance coverage for telephone-telly described in August *Radio-Craft* ("Telly Piped Over Phone Wires!—And With 441-Line Definition") but the American transmissions encompassed a wider frequency range.

Please Say That You Saw It in RADIO-CRAFT



by Littelfuse. Inserted into the high-voltage "B" lead the fuse will prevent energy greater than 5 watts from flowing. The quantity of electrical energy necessary to kill a person has been a matter of controversy for years. However, it has been pretty well established as being far in excess of the 5 watts under discussion.

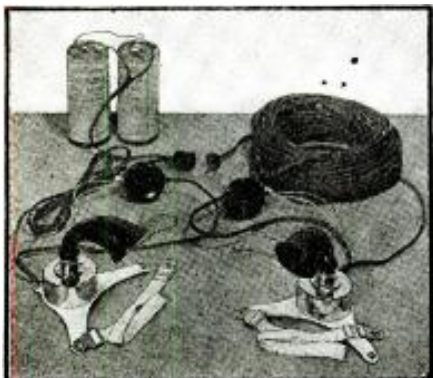

This Stromberg-Carlson, No. 100, portable telephone includes dry-cell-operated breast-plate transmitters. A 200-ft. cable is ordinarily sufficient to reach from the roof antenna to the telly receiver, during installation check-ups.

Finally, there is a liberal education and chance of profit for the Serviceman in building a modern television receiver in kit form, currently being offered by Meissner and Andrea. Both kits use a 5-inch C.-R. tube

and provide sight and sound. In addition to compete constructional details, both makers provide the builder with servicing information, alignment data, antenna installation instructions and trouble-shooting charts.

### TELLY SALES TIPS

A press release from Television Technicians, Inc., said to be the manufacturers' authorized service and television installations and maintenance for RCA Victor, Westinghouse, General Electric, Stromberg-Carlson and other telly set manufacturers, states that the average television home installation will cost much less than the original advertised price (about \$50.—Editor). To quote: "A completed home television installation must, of course, include all materials and installation time, also if desired a continuing service arrangement. An average home installation service charge will be about \$20, less antenna kit and maintenance."

Based on its experience, this telly service group offers the following suggestions to Servicemen-dealers in the New York area: "There are several ways in which receiver sales can be stimulated. First—By comparing their cost with that of other things in common use today. Second—By correcting the wrong impression that installation charges are excessive. Third—By pointing out the rapid improvement in programs since April 30th. Fourth—That another major station will shortly be on the air."

### BUILD THIS 5- TO 20-METER TELLY-SOUND ADAPTER

(Continued from page 157)

somewhat; at the same time the antenna trimmer is varied back and forth over a narrow range. The regeneration control should not be advanced sufficiently far so that the antenna circuit goes into oscillation. If this tuning operation is carefully performed, even very weak signals may be brought up to ample volume.

The effective Hi-Fi Ultra-Shortwave Adapter described may be used to extend the range of any receiver into the higher frequency regions, and it is believed that much enjoyment is to be derived from listening to many of the ultra-high-frequency stations.

(The authors will be very glad to answer any inquiries regarding this new device if stamped and return-addressed envelope is enclosed.)

#### LIST OF PARTS

##### CONDENSERS

- Three Cornell-Dubilier mica, 0.002-mf., C1, C4, C15;
- One F. W. Sickles midget, 20 mmf., C2;
- Two midget 2-gang variables, 30 mmf. (part of Browning Labs., Inc., coil-and-condenser assembly), C3, C14;
- Three Tobe Deutschmann paper, 0.01-mf., C5, C6, C7;
- Three Cornell-Dubilier mica, 100 mmf., C8, C13, C18;
- One Tobe Deutschmann electrolytic, 10 mf., C9;
- Four Tobe Deutschmann tubular paper, 0.05-mf., C10, C11, C12, C18;
- Two electrolytic, 16 mf., 250 V., C16, C17.

##### RESISTORS

- Three I.R.C., 0.1-meg., ½-W., R1, R4, R10;
- One I.R.C., 250 ohms, ½-W., R2;
- One I.R.C. potentiometer, 0.5-meg., R3;
- One I.R.C., 400 ohms, ½-W., R5;
- Three I.R.C., 1.0 meg., ½-W., R6, R9, R11;
- One I.R.C., 0.5-meg., ½-W., R7;
- One I.R.C., 2,000 ohms, ½-W., R8;
- One I.R.C., 10,000 ohms, ½-W., R12;
- One I.R.C., 0.25-meg., ½-W., R13;

- One Ohmite resistance line cord, 220 ohms, R14;
- One I.R.C., 2,000 ohms, 10 W., R15.

##### TUBES

- Two Raytheon type 6SK7;
- One Raytheon type 6SA7;
- One Raytheon type 6SQ7;
- One Raytheon type 25Z6.

##### MISCELLANEOUS

- Two F. W. Sickles air-tuned I.F. transformers, 1,600 kc., T1, T2;
- One Browning Laboratories, Inc., metal cabinet, 6x7x10 ins. long;
- One Browning Laboratories, Inc., dial, 3-3/16 ins.;
- One Browning Laboratories, Inc., tuning assembly (condensers as described; coils may be duplicated by the experimenter per data below).

##### COILS

- L1—Covers from 62. to 48. mc.—1½ turns of No. 16 bare wire (no coil form) diameter ½-in., ¼-in. between turns, tapped at ¾-turn from low-potential end.
  - L2—Covers from 50. to 39. mc.—2¾ turns of No. 16 bare wire (no coil form) diameter ½-in., ¼-in. between turns, tapped 1¼ turns from low-potential end.
  - L3—Covers from 40 to 31. mc.—4¾ turns of No. 18 bare wire (no coil form) diameter ½-in., ¼-in. between turns—tapped at 2 turns from low-potential end.
  - L4—Covers 33 to 25. mc.—4¾ turns of No. 18 bare wire on ½-in. diameter low-loss coil form spaced 1 wire diameter, tapped at 2¼ turns from low-potential end.
  - L5—Covers 25 to 20. mc.—8.05 turns of No. 18 bare wire on ½-in. diameter low-loss coil form spaced 1 wire diameter, tapped at 2½ turns.
- Antenna and oscillator coils are the same. They are mounted on a 4-section, 5-position switch, and form part of the Browning Laboratories' tuning assembly.

## TEST NEW HIGH FILAMENT VOLTAGE TUBES WITH YOUR TUBE CHECKER!

Tiny device plugs into the tube checker and AC supply...enables you to test high filament voltage tubes requiring from 35 to 117 volts! Complete test data with each unit. For use with most tube checkers having loktal sockets. Write, or ask your jobber for complete information. Weston Electrical Instrument Corp., 599 Frelinghuysen Ave., Newark, N. J.

**THE MOST FEATURES in the SMALLEST SPACE**

Smallest midget dry electrolytics on the market—available in more sizes—self-supporting to mount like paper tubulars—all voltages—dual capacity combinations—common negative lead on duals to simplify wiring—build up to higher surges with lower leakage and lower power factor than any other midgets—exclusive vent feature that positively eliminates blow-ups—that, in brief, is the story of Sprague ATOMS. They're fastest selling midgets because they're by far the most reliable. Get next to ATOMS today.

**SPRAGUE PRODUCTS CO.**  
NORTH ADAMS, MASS.

**SPRAGUE ATOMS**

SAVE TIME • MONEY • SPACE

Please Say That You Saw It in RADIO-CRAFT

# FREE - REAL ELECTROPLATING OUTFIT



Now  
You Can **ELECTROPLATE**  
Easily with a **BRUSH**

**S**OMETHING new for radio men—something which gives you the opportunity to make additional profits—or to improve your type of service. Here's an **ELECTROPLATING KIT** amazingly simple to operate—you just Electroplate with a Brush!

## NOT A TOY!

You can electroplate for profit, hundreds of things in the household—ashtrays, fixtures, water faucets, worn brackets, door knobs, musical instruments, jewelry and silverware and other articles. It's an indispensable piece of equipment to you for plating articles in hotels, apartments, office buildings, medical and dental offices, factories, schools, laboratories, etc. Exactly the same outfit (but larger) is used professionally by electricians, radio service men, automobile repair shops, etc. Requires one single dry cell 1½-volt battery to operate.

And for radio work, you can electroplate tarnished receiver parts, escutcheons, contacts, worn radio parts and accessories, and display chassis. Put this **REAL ELECTROPLATING KIT** to use immediately—make it the most useful article in your shop or laboratory. And, you can get it absolutely **FREE** (except for slight mailing cost).

Send your subscription today to **RADIO-CRAFT** for One Year (12 issues) and receive absolutely **FREE** this **REAL ELECTROPLATING KIT**. New subscribers are accepted or you may extend your present subscription another twelve months under this offer. Mail your remittance of \$2.00 (plus 10c for shipping charge on kit) to the publishers of **RADIO-CRAFT** (Canada and foreign \$2.35). You will promptly receive your **FREE, REAL ELECTROPLATING OUTFIT** by return mail. Use the coupon below to order your subscription.

## RADIO-CRAFT

99 Hudson Street New York, N. Y.

RADIO-CRAFT RC939

99 Hudson Street, New York, N. Y.

Gentlemen: Enclosed you will find my remittance of \$2.00 for which enter my subscription to **RADIO-CRAFT** for One Year (12 issues). Send me promptly my **FREE, REAL ELECTROPLATING OUTFIT** (Canada and foreign \$2.35). In U. S. add only 10c additional to cover shipping charges on kit.

New Subscriber  Extend Present Subscription

Name .....

Address .....

City ..... State .....

(Send remittance by check, money order or unused U. S. Postage stamps. Register letter if you send cash or stamps.)

## MARINE RADIO TELEPHONE—LATEST FIELD FOR SERVICEMEN

(Continued from page 145)

must be made by an operator holding a regular 1st or 2nd Class commercial license, and these adjustments locked. The only transmitter adjustment permitted to the 3rd Class operator is manipulation of a band-switch to shift from one pre-set frequency to another as occasion requires.

### FREQUENCIES

The F.C.C. has set aside 2 regular operating ranges for this service: 2,500 to 2,600 kilocycles for the telephone company's shore transmitters, and 2,100 to 2,200 kc. for the transmitters aboard boats. In addition, the frequency of 2,738 kc. is assigned for direct boat-to-boat communication. The frequency of 2,670 kc. may be used, in emergency only, for direct communication with the Coast Guard.

Each shore transmitter has its own fixed operating frequency and receives on one frequency, standing by continuously on this frequency. The marine exchange station at New York, for instance, transmits on 2,590 kc. and receives on 2,198 kc. To transmit to, or receive from, this station therefore requires that the boat's receiver be tuned to 2,590 kc. and its transmitter to 2,198 kc. Should the boat move into the Boston service area it will hear the Boston exchange on 2,506 kc., and will have to shift its transmitting frequency to 2,110 kc. to contact this land station.

The equipment on board is selected according to the service area required, with due thought to the available power supply source. A harbor tug, for instance, may never be more than perhaps 15 miles from the marine exchange of that harbor (or one of its listening posts) and in that case a power of a few watts into its antenna may be ample. But coastal tugs, fishing and pleasure boats, with their greater range of travel, will require greater power to provide a proportionately greater service area. There is also the question of antenna efficiency. Maximum transmitting efficiency on these frequencies requires an antenna approximately 85 feet in length. If the boat is too small to accommodate an antenna of this size a sacrifice in efficiency necessarily follows and proportionately higher power is needed.

The transmitter for boats must provide the utmost operating simplicity and the ability to maintain its adjustment and stand-up under marine service because if anything does go wrong its 3rd Class operator is not permitted to correct the condition and it will therefore be out of service until an authorized higher-grade operator is found to do the job.

It is considered that a transmitter which provides a 50-watt carrier represents the happy medium for boats with other than a purely "local" radius of travel. This power is ample to provide a good area of coverage without imposing too great a drain on the power supply source of commercial and pleasure boats of the class which could logically utilize this harbor radio system. Even for "local" service this is a practical value of power as it provides a reserve to compensate for unfavorable local or atmospheric conditions, inadequate antenna facilities, etc.

### INSTALLATION

The job of installing a transmitter for this type of service is not in any way complicated; much less so, for instance, than installing a public address system of equivalent power. Commercially-built, self-con-

tained equipment is utilized almost exclusively and is designed to simplify installation. The erection of a suitable antenna, and provision of ground and supply connections to the boat's batteries (or other type of supply) usually completes the installation.

The first step in making an installation is to study the boat and its habits. If its travels are confined to a harbor where there is a shore telephone station a low-power rig will serve but if it regularly or occasionally travels extensively then a transmitter capable of putting 50 watts or so into the antenna will be needed.

A suitable "ground" consists of a metal plate (which may be the metal hull of the boat or a metal plate attached to a wood hull) in direct contact with the water. This point should be within reasonable distance of the transmitter because the ground-lead constitutes a part of the antenna system.

The most practical type of antenna is one of the inverted-"L" type and a quarter-wave long including its leadin and the ground lead. Inasmuch as the lowest transmitting frequency will be about 2,100 kc. this would make the overall antenna length approximately 85 feet. Where the size of the boat does not permit the use of one of this length a loading coil may be used at the transmitter to compensate for the deficiency. In some transmitter equipment an adjustable coil is included within the transmitter for this purpose. The transmitter should preferably be located so as to provide minimum length of leadin within the boat structure. Insulation of this leadin and the antenna itself should be much more thorough than in the case of the ordinary receiving antenna to avoid losses due to moisture, soot and perhaps even salt spray which may be deposited on the insulators.

Most boats depend on storage-battery supply, either 12 or 32 volts. The available source of power supply must, of course, be determined before ordering equipment. Most commercial radio equipment can be supplied for operation from 12-, 32- or 110-volt supplies.

The fact that most boat supply systems are of the low-voltage type means that the supply leads to the transmitter must be rather husky. A transmitter which puts 50 watts into the antenna will draw somewhere in the neighborhood of 400 watts total from the power supply. In the case of a 12-volt supply this means a drain of from 30 to 40 amperes—and you can't run this amount of soup through a pair of No. 16 wires! Number 8 wire is a good practical size. It is equally important that all connections be tight and clean and that any plugs and receptacles in the line be of ample capacity to carry the required amount of current. The line length should, of course, be as short as possible to keep its resistance low and, needless to say, should be properly protected against physical damage, and moisture.

There is no need here for going into details as to the tuning and adjustment of equipment as manufacturers provide complete instructions with each piece of equipment. The one unusual feature about the actual tuning of the transmitter is that this operation must be performed by a holder of one of the higher grades of commercial radio operator's licenses if the transmitter is connected to the antenna. An unlicensed operator can make adjustments when working into a dummy antenna (provided it does not radiate to any appreciable extent) but that is as far as he can go. In the

Please Say That You Saw It in **RADIO-CRAFT**



final tuning of transmitter and antenna the services of a "pro" operator must be utilized. This applies not only after the original installation but also after any subsequent alterations or adjustments of transmitter or antenna system which might affect any of the tuned circuits.

Servicing which may be required from time to time will more likely have to do with the antenna, power supply or receiver than with the transmitter proper as marine equipment is usually of especially rugged design and as near "breakdown proof" as possible. Moreover, these transmitters are in actual operation very little of the time so that even the tubes are likely to stand up indefinitely. For the occasional jobs where something has actually gone wrong with the transmitter the usual tests made on receivers will usually disclose the trouble. It is an advantage, however, if the Serviceman has a good working knowledge of transmitters and the principles involved. The Serviceman who is also a "ham," or has had experience as a commercial operator will therefore have a slight edge over others in handling both installation and service jobs of this sort. In either case, the installation and maintenance of marine radio equipment is right up the alley of any "home-radio" Serviceman fortunate enough to live near large bodies of water.

**EQUIPMENT**

An example of equipment especially designed for this type of installation is shown in the accompanying photos, with the complete schematic circuit in Figure 1. This is the Hallcrafters model HT-3 and consists of the transmitter, receiver and power supplies, all built into a single table-mounting steel cabinet approximately 30 inches long, 12 inches high and 19 inches deep.

The transmitter section provides a correctly-modulated carrier output of 50 watts (the preferred power as mentioned above), the choice of any 3 selected frequencies by band-switching, and complete simplicity of operation. Its only controls are the band-switch, the meter switch which provides a check on correct operation, the main off-on switch and the "push-to-talk" switch conveniently located on the hand-set.

The receiver is a 6-tube superheterodyne which covers 2 bands; the standard broadcast range, and 1,900 to 3,100 kc. which includes the range assigned for the services in which this transmitter operates. It is equipped with interstation noise suppression with threshold sensitivity adjustable to the level of existing noise. For standby service or for broadcast reception the built-in speaker is utilized but when the hand-set is lifted off the hook for actual communication the receiver output is automatically switched to the headphone in the hand-set. The receiver has 4 controls located on the left-hand panels. These are the tuning and volume controls, situated either side of the dial on the upper panel, and the band selector and "on-off" switches on the lower panel. The receiver section can be turned on independently of the transmitter.

The lower right-hand panel includes the switch which permits the meter to be used to check grid, R.F. plate, and modulator plate currents of the transmitter, or filament voltage; and the transmitter "on-off" switch.

The control on the center panel is the transmitter band-switch. This provides selection of any one of 3 operating frequencies, switching the crystals and the corresponding tuned circuits of the oscillator, R.F. final and antenna loading coil. Normally the 3 frequencies for which the transmitter is adjusted on installation are: (1) the channel assigned for land telephone

service in that area; (2) Coast Guard emergency frequency; and, (3) the ship-to-ship channel. Thereafter any one of these is selected as desired by the flick of this switch. When operating the transmitter, pressure on a button in the hand-set cuts the receiver plate supply, turns on the transmitter plate supply and switches the antenna from Receive to Send positions. All of this is accomplished by built-in relays.

The dual power supply consists of a 450-volt dynamotor for the transmitter and a vibrapack for the receiver. All filaments are operated on D.C. and the entire system is designed for operation from the conventional ship's 12-volt battery. It can, however, be supplied to operate from other D.C. voltages on special order. The circuit of Fig. 1 shows the arrangement for operation from a 32-volt source, the dotted lines indicating the changes for 12-volt operation.

A novel feature of the modulator is that no voltage amplifier stages are required. The power sensitivity of the 6L6's is such that the microphone output is sufficient to drive these 4 tubes for full modulation.

The physical and electrical design of the equipment as shown in top and bottom views is such that sturdiness is combined with ready accessibility of all parts of the circuit for adjustment or servicing. All actual tuning adjustments in the transmitter are made by removing the top cover to provide access to the 6 screwdriver-adjustment holes. These screws are all of the locking type and, once adjusted, cannot shift. The antenna loading adjustments are made by means of movable taps on the coupling and loading coils. This arrangement is made necessary by the variety of antennas encountered on board ship, and permits adjustment for maximum efficiency with any particular antenna.

**CONCLUSION**

The question may naturally arise in the mind of the Serviceman or custom builder as to why he cannot build equipment for this service. There is nothing to stop him, provided he can hurdle the matter of licensing under the existing RCA and the A. T. & T. patents. This field is a distinctly commercial one and patent rights are likely to be guarded more jealously than in the other non-commercial fields in which the custom set builder normally operates. It is of interest to note that the above equipment is the first of independent make to be fully licensed under the patents of the above companies.

There is also a question as to just what would be gained by constructing the equipment as it is extremely doubtful whether the custom builder could compete in price with standard production equipment such as that described, at the same time maintaining the same standard of dependability, stability, simplicity and compactness.

There is, however, money to be made in installation and service and it is in this direction that the Serviceman will find his logical opportunity.

**Schematic Values**

(Continued from page 145)

R21—150	R38—50
R22—2,500	R39—110, 10 W.
R23—100	R40—6,000, 1 W.
R24—10,000, 10 W.	R41—30 ma. shunt
R25—9,000, 10 W.	R42—2,000, 10 W.
R26—0.25-meg.	R43—20,000, 2 W.
R27—0.5-meg., Pot.	R44—10,000, 10 W.
R28—400, 1 W.	R45—300 ma. shunt
R29—5,000	R46—300 ma. shunt
R30—100, 1/4 W.	R47—6,000, -2%
R31—20, 25 W. adj.	R48—6,000, 10 W.
R32—32, 2 W.	R49—50
R33—21, 5 W.	R50—50
R34—10, 50 W., adj.	R51—50
R35—575, 20 W.	R52—50
R36—10,000, 10 W.	R53—11, 10 W.
R37—50	R54—400, 10 W.

**FREE!**

and it saves you  
**TIME,  
TROUBLE,  
MONEY**



This FREE catalog is your dish. Has everything in Radio — thousands of parts, tubes, Test Instruments, Sound Systems, Receivers, build-it-yourself kits, etc. Every item nationally advertised, arranged for quick, easy reference. Order at home. Save time and trouble. And take advantage of real money saving prices. Not just on some items. There's value after value right through this book's 188 pages. You save on everything you buy! Send at once for your copy. Remember, it's FREE! Just tear out and mail the coupon NOW.

**LAFAYETTE**  
RADIO CORPORATION  
WHOLESALE RADIO SERVICE CO., INC.

Rush New FREE Catalog No. 76

NAME \_\_\_\_\_ PLEASE PRINT

ADDRESS \_\_\_\_\_

CITY \_\_\_\_\_ STATE \_\_\_\_\_

**LAFAYETTE RADIO CORPORATION**  
Dept. 3J9 — 100 Sixth Ave., New York, N. Y.

PASTE COUPON ON PENNY POSTCARD

SALES OFFICES IN  
NEW YORK 100 Sixth Avenue  
CHICAGO 801 W. Jackson Blvd  
ATLANTA 265 Peachtree Street  
Boston, Mass. Dept. H. T.  
Newark, N. J. Jamaica, L. I.

**Anti-Obsolescence**  
**PUSH BUTTON**  
**VIBRATOR TESTER**



Model 1671  
Dealer Net Price **\$39.84**

with **RED DOT Lifetime**  
**Guaranteed Instrument**

- Tests All Standard 6-Volt Vibrators.
- Easy to Operate — Roll Chart Has 107 Key Settings, making up Every Connection Combination. Future Vibrators use Same Settings with References Furnished or Easily Calculated. Chart needs no changes as new vibrators appear.
- Flexible Push-Button Switching Permits Placing Proper Voltages on Each Reed—Obsolescence Proof.
- Uses Approved 5000 Ohm-8 Mfd. Load.
- Tester is Fused Against Shorted Vibrators.

In the new Model 1671 the obsolescence proof push-button feature eliminates difficulties experienced in keeping other types up to the minute for testing the new vibrators constantly appearing.

Model 1671—In New Streamlined Case with black suede electro enamel finish... complete with cover and accessories... Dealer Net Price... \$39.84.

Ask Your Jobber or Write for Complete Catalog Section 169

**THE TRIPLETT ELECTRICAL INSTRUMENT CO.**  
Bluffton, Ohio

Please Say That You Saw It in RADIO-CRAFT

..... *Attractive*  
**MODERN DESK LAMP**  
*Absolutely FREE*  
 READ THE DETAILS .....



↑  
**THIS  
 SHADE  
 TILTS  
 UP AND  
 DOWN**

**JUST THINK OF IT**—you can get absolutely **FREE**, the beautiful desk lamp which is shown above. This attractive desk lamp is suitable for home, desk, den, office, laboratory, studio or workshop. It is sent to you by the publishers with their compliments for a one-year subscription to **RADIO-CRAFT**. Look at the many fine features which this handsome desk lamp has. Read the list below.

**HERE ARE THE LAMP FEATURES!**

- ⊙ Constructed of metal with attractive bronze finish.
- ⊙ Scientifically constructed to give glareless, diffused light.
- ⊙ Helmet-type shade can be tilted to any convenient angle.
- ⊙ Stands 13" high and has 10" metal shade.
- ⊙ 5-foot rubber insulated cord and plug.
- ⊙ Constructed to last for many years.

**Clip Coupon Today — and Mail!**

Send your subscription today to **RADIO-CRAFT** for One Year (12 issues) and receive absolutely **FREE** one of these truly remarkable desk lamps. New subscribers are accepted or you may extend your present subscription another twelve months under this offer. Mail your remittance of \$2.00 (Plus 25c for shipping charges on lamp) to the publishers of **RADIO-CRAFT**. (Canada and foreign \$2.75.) You will promptly receive your **FREE DESK LAMP** by return mail. Use the coupon below to order your subscription.

**RADIO-CRAFT**

99 Hudson Street NEW YORK, N. Y.

**RADIO-CRAFT**

99 HUDSON STREET, NEW YORK, N. Y.

Gentlemen: Enclosed you will find my remittance of \$2.00 for which enter my subscription to **RADIO-CRAFT** for One Year (12 issues). Send me promptly my **FREE DESK LAMP**. (Canada and foreign \$2.75.) In U. S. add 25c additional to cover shipping charges on lamp.

- ( ) NEW SUBSCRIBER  
 ( ) EXTEND PRESENT SUBSCRIPTION

Name .....

Address .....

City ..... State .....

(Send remittance by check, money order or un-  
 used U. S. postage stamps. Register letter if you  
 send cash or stamps.)

RC-9-39

**HOW TO MAKE A MODERN  
 RADIO TREASURE LOCATOR**

(Continued from page 147)

take the receiver and loop frame about 10 or 15 feet away. Turn on the receiver and adjust the padder screw on the front panel for the loudest tone from the headphones, then adjust the 4 I.F. trimmers in succession for loudest tone, but be careful to adjust well below the point of oscillation, which, should it occur will be evidenced by violent wagging of the meter needle and a shrill whistle in the phones.

Finally attach the receiver and transmitter assemblies, as shown in Figs. 9, 10, 11, together with the carrying handles and you are all set for metal exploring. Good luck, and we hope you find a million in treasures.

**LIST OF PARTS**

Lumber, finished pieces—

- Four pc. 24 in. x 2 in. x ½-in.;
- Four pc. 23 in. x 2 in. x ½-in.;
- Two pc. 24 in. x 24 in. x ¼-in.;
- Two pc. 48 in. x 3 in. x 1 in.;
- Four pc. 12 in. x 4 in. x ½-in.;
- Four pc. 11 in. x 4 in. x ½-in.;
- Two aluminum panels 12 x 12 ins., No. 16 gauge;
- Two aluminum subpanels 10 x 4 ins., No. 16 gauge;
- One aluminum sheet 8½ x 4 ins., No. 20 gauge;
- Two Sylvania 1A5G tubes, V1, V2;
- Two Sylvania 1N5G tubes, V3, V4;

- One Sylvania 1H5G tubes, V5;
- Three "B" batteries, 45 V, Eveready No. 727;
- Two "A" cells, 1.5 V. Burgess No. 4FH;
- One Meissner I.F.T., No. 16-5728, L1;
- One Meissner I.F.T., No. 16-5730, L2;
- One Meissner choke, No. 19-1907, L3;
- Two Meissner padders, No. 22-7029, C1, C2;
- One I.R.C. resistor, 1 watt, 3 megohms, R2;
- One I.R.C. resistor, ½-watt, 1 megohm, R3;
- One I.R.C. resistor, ½-watt, 0.5-meg., R4;
- One I.R.C. resistor, ½-watt, 0.1-meg., R5;
- Two Cornell-Dubilier tubular condensers, 0.1-mf., 200 V., C1, C2;
- One Cornell-Dubilier tubular condenser, 0.01-mf., 200 V., C3;
- Two Cornell-Dubilier mica condensers, .001 mfd., C4, C5;
- One Cornell-Dubilier mica condenser, .004 mfd., C6;
- Two Cornell-Dubilier mica condensers, .0002 mfd., C7, C8;
- One half-pound spool Corwico magnet wire, No. 24 enamled;
- One roll Corwico hookup wire, No. 20 tinned;
- One pair tip-jacks, American Hardware Co.;
- One Simpson Microammeter, 0-200 micro-amperes, 3-in. square case;
- Five Amphenol octal sockets;
- Two Cutler-Hammer toggle switches, ½-in. shank, S.P.S.T. Sw. 1-2;
- One Centralab Variable Control, No. 72-104, 0.1-meg., R1.

**TELEVISION EXPERIMENTS WITH A SERVICING 'SCOPE**

(Continued from page 177)

- Three I.R.C. resistors, type BT1, 10,000 ohms, 1 W., R3, R7, R9;
- Four I.R.C. resistors, type BT1, 60,000 ohms, 1 W., R4, R8, R14, R19;
- One I.R.C. resistor, type BT½, 0.1-meg., ½-W., R5;
- One I.R.C. resistor, type BT½, 750 ohms, ½-W., R6;
- One I.R.C. resistor, type BT½, 3,500 ohms, ½-W., R10;
- Two I.R.C. resistors, type BT1, 2,000 ohms, 1 W., R12, R17;
- Two I.R.C. resistors, type BT1, 5,000 ohms, 1 W., R13, R18;
- One I.R.C. resistor, type BT½, 0.25-meg., ½-W., R15;
- Three I.R.C. resistors, type BT½, 2,000 ohms, ½-W., R20, R21, R22;

**TUBES**

- Four RCA Radiotron all-metal tubes, type 1852;

- One RCA Radiotron all-metal tube, type 6H6;
- One RCA Radiotron tube, type 906-P1 (this tube is specially designed for television service and is recommended, as a direct-replacement of the "oscilloscope" type of C.-R. tube ordinarily supplied in service oscilloscopes, where greater resolution or detail is desired).

**MISCELLANEOUS**

- Five National isolantite sockets, octal base;
- \* One 6-post terminal strip;
- \* One 3-post terminal strip;
- \* One power supply 400 V.;
- One DuMont oscilloscope, type 164 (employing 3-in. cathode-ray tube);
- Two American Radio Hardware antennas, No. 7;
- Panel is electralloy, 7½x10x1/16-in. thick; chassis, 1/16-in. thick, is 7x9x2 ins. high; Hardware, wire, aluminum (for panel and chassis), etc.
- \* Supplied by Wholesale Radio Service Co.

**NEW CIRCUITS IN MODERN  
 RADIO RECEIVERS**

(Continued from page 173)

are tuned by pre-set trimmers operated by pushbuttons.

In Fig. 2B is shown the arrangement. It is the simplest possible arrangement of a push-button tuning system. Although the transformers are of the "filled"-core type, they have slight capacitative coupling added in addition to their inductive coupling and there are no variable tuning condensers for manual tuning.

**BEDSPRING RADIO**

A lawyer living in the vicinity of radio station WBBM, Glenview, Ill., reported that his bedsprings reproduced this station's programs! The *Chicago Herald-Examiner* in reporting on this "unique radio receiver" pointed out that the rusty springs rectify the electromagnetic component of the transmitted wave and convert this component into sound waves.

**NEXT MONTH**—How to Make an "A" and "B" Power Supply to Operate Battery Portables from the Light Line—October *Radio-Craft*.

Please Say That You Saw It in **RADIO-CRAFT**



# RADIO TRADE DIGEST

## SALES HELPS & DEALS

(Continued from page 164)

Wis. "Gift song" is included in show; after program, show's M.C. calls at doors, asks householders to name song. If they can, they get midget radio, 10 of which are given daily. Station's promotion dept. thinks dealers can cash in on this "stimulus to create interest in secondary radios." Show is "Top o' the Morning."

## PERSONAL

(Continued from page 164)

mains managing director. 1940 show will be held in Chi.

WALTER R. JONES, head of Sylvania's Commercial Eng. Dept., returned from Pacific Coast trip, reporting most successful series of service meetings he ever held in that territory.

Conn. Tel. & Elec. Corp. has a new exec. staff:—Pres. H. W. HARWELL; V.-P. & Sales Mgr., FRANK HOLMSTROM; Secy.-treas., C. A. CUNNEEN; Adv. Mgr., C. H. GILLETTE.

FRED KUGEL, Manhattan; ARTHUR LAX, Bkln.; WM. F. WALKER, L.I.; SIDNEY LANE, Westchester; M. B. MEYERS, Bronx, & M. B. LAJOIE, N.J., will represent Du Mont Labs. in metropolitan N.Y. & N.J. NORMAN C. HALL has been made the Lab.'s service manager.

RICHARD T. ORTH, head of receiving tube design section of RCA's Harrison plant, was awarded a Sloan Foundation fellowship for advanced study of industrial problems at M.I.T., and has been given a yr.'s leave of absence by his co.

THIRTEEN Philco execs., headed by Pres. LARRY GUBB, took a U.S. tour of 52 cities to cover dealer & distrib. meetings. By the way, 52 is 4 x 13. Isn't it nice to be free from superstition?

JOSEPH C. ELLIFF, formerly western mgr. of the Saturday Evening Post, has joined Stewart-Warner Corp. in an executive sales capacity. J. R. BRANDENBURG has been appointed northwestern district mgr. H. P. DUNKLEY has been transferred to the Metropolitan N.Y. area.

## TELEVISION TIPS

(Continued from page 166)

### "Images at 130 Mi."

General Electric engineers, running tests 130 mi. from NBC xmtr, received telly programs well on diamond-shaped antenna about 300 x 600 ft. Horizon, contrary to early beliefs, did not stop waves.

### "Installation Fees"

Dealers & Servicemen are getting fat fees on installations. Cost quoted by Television Technicians, N.Y.C., is \$20 plus antenna kit. This is considered reasonable.

### "Like Airplanes"

"Television will have about the same effect on the sale of radio sets as airplanes have on the sale of automobiles," says F. A. Hiter, Stewart-Warner sales mgr. Reason he gives is that telly will "supplement radio—not supplant it".

### "RMA's Icwater"

Bd. of Directors of the RMA issued a not-too-optimistic statement on telly, explaining that "over 90% of the geographical area of the U.S. will not be served for some time". What percentage of the population will get immediate service was not stated.

### "Du Mont License"

Majestic Radio & Tel. Corp. has added Du Mont license to the RCA & Hazeltine licenses it already holds. Co. plans complete line of sets.

### "Warner Steps Out"

Warner Bros. have sold out their interest

in Transamerican Bcstg. & Tel. Corp., according to Radio Daily.

### "WOKO Goes Facsy"

WOKO, Albany, has taken a Finch facsy license, & plans xmsns soon.



(Continued from page 166)

Eddie Spiegler, who was the General Winding Co., has opened a new plant in Conn. . . . Arcturus has 6 new 1.4 V. tubes, which require a max. of 90 V. "B." . . . De Wald probably won't have their telly sets out until Spring; too busy making best sets. . . . RCA dropped the price of its aerodynamic mikes—down \$3 on M16226D; down \$4 on M16228B. . . . The price on those Stewart-Warner 26-tube telly sets will be about \$500. . . . Du Mont has a new tube for 2-way television.

Universal Microphone Co. now makes its mikes under license from Western Electric, ERPI & A.T.&T. . . . RCA tube dealers & distributors are now getting 4 kinescopes, 3 telly amplifier pentodes & 2 hi-vac rectifiers. . . . Western Electric is offering a new 2-way radiophone for police use. . . . St. Patrick's Cathedral & the Cathedral of St. John the Divine, both N.Y.C., have installed RCA sound systems.

Get a load of the G-E line for 1940; many models & new features—too many to list here. . . . ABC Radio Labs. has a new police converter, priced about half of their next cheapest similar unit. . . . Emerson Radio is sponsoring those controversial bcsts by Elliot Roosevelt on the Mutual tentacles. . . . With gift season coming soon, think of G-E's clocks as a sideline; there're 6 new models.

A complete line of Sylvania tubes, from 199's to Loktals, is in the Ford-Edison Institute at Dearborn, Mich. . . . 8 types of dial lights have been added to the Arcturus line; they come 10 to the familiar white-black-&-blue carton. . . . Ampro Corp. has a new sound-proof 16mm. sound movie projector. . . . Consolidated Wire announces a new line of w-w resistors; 4 sizes adjustable—4 sizes fixed. . . . Triplet Elec. Inst. Co. closed down the wk. of July 3 to give all employes a vacation. . . . G-E has 3 new portables (10 lb. with batteries).

## A Reader Says:

Attention: HIZONER "Snoops & Scoops"—

Greetings:

In looking through that great journal of light and learning this morning I was simply mortified to find a JOBBER of radio coils getting credited in your column for "precision-made coils as to be interchangeable."

In looking over the records that pertain to my baby, — DX RADIO PRODUCTS, I find that in February I sent a catalog to your publication, telling the story in words and pictures about DX Coils, but nary a mention.

Somebody has done you wrong and so under separate cover directed to your attention is a real catalog describing real coils, actually precision-made for such well known manufacturers as Travler, Sonora, Wells-Gardner, Belmont and others, and now available for jobbers.

Then if DX doesn't rate at least a line about their superb catalog, their precision-made coils all made in one plant too, and not purchased from several sources, a wow of a trade mark by virtue of the fact that ex-W9DX is the Chief Engineer, a peach of a carton, and all of it backed with prompt shipment,—then please tell

**YOU CAN BECOME A MONEY-MAKING RADIO EXPERT**  
WITH THE **NEW SPRAYBERRY**  
*Personalized*  
**HOME TRAINING in RADIO and TELEVISION**

**You Learn Easily in Your Spare Hours . . . By Doing Many Experiments with Up-To-Date Equipment**

Here's a really fine, up-to-the-minute Radio and Television Training that's specially designed to give you quick results. **TRAINING PREPARES YOU FOR GOOD RADIO JOBS . . . AT EXCELLENT PAY.** My training starts right at the beginning of Radio . . . unfolds each subject in a simplified, logical, understandable style. You easily learn: Television, Electronics, Facsimile Radio, Radio Set Repair and installation Work, etc.

**NO PREVIOUS EXPERIENCE NEEDED**  
It makes no difference what your education has been. I can fit you for a good-paying Radio job. Your success is my full responsibility.

**YOU GET PROFESSIONAL TEST EQUIPMENT PLUS EXPERIMENTAL OUTFITS**  
. . . Includes 146 Radio Parts (to build complete Receiver), Tools, All-Wave, All-Purpose Analyzer, and Experimental Outfits for conducting actual experiments with your own hands.

**EARN WHILE YOU LEARN**  
My **BUSINESS BUILDERS** show you how to put your Equipment to practical use in handling actual money-making Radio Service Jobs shortly after you begin training.

**SERVICEMEN**  
I offer Advanced Training for those already in Radio. Get complete details in my FREE 52-page Book. *The Sprayberry Course is Sold Under a Money-back Agreement*

**RUSH COUPON FOR BIG FREE BOOK**

**SPRAYBERRY ACADEMY OF RADIO**  
F. L. Sprayberry, Pres.  
250-J University Place, N.W.  
Washington, D. C.

Please send me FREE copy of "HOW TO MAKE MONEY IN RADIO."

Name . . . . . AGE . . . . .  
Address . . . . .  
City . . . . . State . . . . .  
Tear off this coupon, mail in envelope or paste on penny postcard. Servicemen—check here ☐

**I Supply**

- 146 RADIO PARTS
- RADIO TOOLS
- ALL PURPOSE ANALYZER

**FOR TUBES OF TODAY and TOMORROW . . .**

*Readrite RANGER*

**MODEL 432-A**

**RED-DOT**  
LIFETIME GUARANTEE

**TRIPLETT METER**

Only **\$17.85** NET

- Sockets for All Tubes.
- Filament Voltages from 1 to 110—A Safeguard Against Obsolescence.
- Precision Indicating Instrument With Two Highest Quality Sapphire Jewel Bearings.
- Separate Line Control Meter.
- Neon Shorts Test.
- Etched Panel of outstanding New Design.
- Approved RMA Circuit.
- Portable Rich Black Leatherette Covered Case — Professional in Appearance.

**TODAY'S** outstanding tube tester value—a guaranteed quality portable tester at a price you can afford to pay. Checks Loktals, Single Ends, Bantam, Jr., Gaseous Rectifier, Ballast, the New High Voltage Series (including 11726G and others recently announced). Direct Reading GOOD-BAD Meter scale. Positively will not deactivate 1.4 volt or other type tubes.

Model 432-A-742—a combination Tube Tester and Volt-Ohm-Milliammeter, in similar case, but slightly larger. Dealer Net Price . . . . . \$26.85

Write for Information—Section 916

**READRITE METER WORKS, Bluffton, Ohio**

## OPPORTUNITY AD-LETS

Advertisements in this section cost five cents a word for each insertion. Name, address and initials must be included at the above rate. Cash should accompany all classified advertisements unless placed by an accredited advertising agency. No advertisement for less than ten words accepted. Ten percent discount for six issues, twenty percent for twelve issues. Objectionable or misleading advertisements not accepted. Advertisements for October, 1939, issue must reach us not later than August 7th.

Radio-Craft • 99 Hudson St. • New York, N. Y.

### AGENTS WANTED

**300% PROFIT SELLING GOLD LEAF LETTERS FOR store windows:** Free samples. Metallic Company, 451 North Clark, Chicago.

### BOOKS AND MAGAZINES

**WE HAVE A HUNDRED RADIO ENCYCLOPEDIAS.** By S. Gerritsback, second edition, originally sold at \$3.98. Book has 352 pages, weight 3 lbs., size 9 x 12 inches. Red morocco-keratol flexible binding. Send \$2.49 in stamps, cash or money order and book will be forwarded express collect. Technifax, 1915 So. State Street, Chicago, Illinois.

### CAMERAS & SUPPLIES

**GENERA FILM—ALL MOVIE CAMERAS. 100 FEET 8 mm., \$1.00; double, \$1.75; 16mm., \$1.35.** Sample for stamp. Processing Powders, Outfits, Promoters, Davenport, Iowa.

**BULK FILM: 100 FT. 8MM. \$9.00; DOUBLE, \$16.00; 16 mm., \$1.20.** Titles of pictures, Chemicals, outfits. Big catalogue for stamp. Hollywoodland Studios, South Gate, Calif.

### DIRECT COUPLED AMPLIFIERS

**DIRECT COUPLED AMPLIFIERS DESCRIBED IN July, 1939, Radio-Craft. Basic Kit 10 Watt Model \$9.68; 20 Watt Model \$14.52.** Send for Free Circular. Amplifier Co. of America, 17-19 West 20th Street, New York City, N. Y.

### EDUCATIONAL COURSES

**USED CORRESPONDENCE COURSES AND TECHNICAL Books Bought, Sold, Rented, Exchanged. Catalog Free.** Vernon Educational Exchange, Henagar, Ala.

### FOR INVENTORS

**CASH FOR UNPATENTED IDEAS. STAMP APPRECIATED.** Mr. Hall, 9141-J Pleasant, Chicago.

### FORMULAS

**FORMULAS FOR MAKING INSECTICIDES, ANTISEPTICS, Bleaching Solutions, Cements for All Purposes, Stain Removing Preparations, Cosmetics, Depilatories, Dyes, Fertilizers, Fire Extinguishing Preparations, Inks, Lacquers, Paints, Plating Solutions, Soaps, Varnishes, Wines and Liquors, and Many Everyday Preparations.** Send 10c for each formula. Complete satisfaction or money immediately refunded. L. Feldman, 640 Hamapo Rd., Teaneck, N. J.

### HOMES WIRED FOR RADIO

**ARCHITECTS, BUILDERS, HOME-OWNERS!—PLAN for concealed, built-in radio in every room. Put radio in attic, cellar or closet, tune it remotely from any room. Up to 4 different stations heard independently in each room. We supply complete plans and specifications for your individual requirements. We also sell all necessary equipment and actual installations. Write for prices and complete details. A. Stuart, 1015 Wilson Ave., Teaneck, N. J.**

### MISCELLANEOUS

**MEXICAN DIVORCES; NO PUBLICITY. AMERICAN attorney.** Box 1736, El Paso, Texas.

**10 ARROWS FROM 10 DIFFERENT STATES—\$1.00.** 100 good arrows prepaid—\$3.00. 100 fine arrows prepaid—\$5.00. List free. Caddo Trading Post, Glenwood, Ark.

**GENUINE ELGIN ELECTRIC RAZORS. PRECISION built, one year guarantee.** Get yours now at only \$2.95. Send only \$1. Balance C.O.D. Dept. 119, Box 87, Ft. Payne, Alabama.

### OFFICE SUPPLIES

**SEND COPY AND \$1.00 FOR 125 8 1/2 x 11 BOND Letterheads and 125 envelopes, both beautifully printed.** Ben nettie, 907 West Roosevelt, Philadelphia.

### RADIO

**WE BUY AND SELL USED RADIO TESTING EQUIPMENT.** Time payments if desired. Harold Davis, Inc., Jackson, Miss.

**CONDENSER TESTERS, PHONO PICKUPS. USED silbitch—In A1 condition. Write for list.** The Radio Shop, Box 101, Hanover, Illinois.

**8-TUBE CAR-RADIO WILL SWAP ARVIN CAR SET in good working condition. Has 12-in. speaker (fine tone). Offer cash or camera or what have you?** Duane Bernard, 40 Manning Ave., No. Plainfield, N. J.

**ALGEBRA PROBLEMS SIMPLIFIED \$1.30; LOW Voltage Transformer Construction \$0.60; Data on 500 to 20,000 Volt Step-up Transformer Construction \$1.35.** H. Ackerson, Box 392, R. Ramsey, N. J.

**BRAND NEW, GUARANTEED, RADIO TUBES 25c each.** Box 37, Station P, Brooklyn, N. Y.

### TREASURE LOCATORS

**TREASURE FINDER (METAL LOCATOR) CUSTOM built by engineer. Great penetrating power. No fancy gadgets. Uses latest radio developments. Simple, inexpensive to operate. Delivery ten days. Write for details and low price.** A. Stuart, 1015 Wilson Avenue, Teaneck, N. J.

## RADIO TRADE DIGEST

(Continued from preceding page)

me what's wrong and I'll promptly get into some other line of business.

And when I think that we have been able to attract and hold such outstanding sales representatives as Don Wallace, W6AM, on the Pacific Coast, Jim Schoonmaker in Texas, Okla., La. and Ark., Fred Somers for Kansas, Mo., Tex. Leonard for Minnesota, Wisconsin, North and South Dakota, Montana, Nebraska and Iowa, Bill Lee for Michigan, Murphy & Cota for the South-Eastern states, Adolph Schwartz for the middle-Atlantic States, Simmons & Southern for Indiana, Ohio and Kentucky, and Charles Blount, for the New England States.—oh me!!!!!!

Cordially yours,

J. M. Trittenbach.

## OFF THE PRESS

(Continued from page 166)

**CATALOG 166A.** Cornell-Dubilier Elec. Corp., S. Plainfield, N.J. Describes entire Quietone Filter Interference line.

**CATALOG 167A.** Same Co. Describes new condenser test instrument line.

**PROTECTION FOR YOUR SERVICE INSTRUMENTS.** RCA Mfg. Co., Inc., Camden, N.J. 4 pp. Outlines policy, & tells of taking over Rider Chanalyst & VoltOhmyst.

**CONDENSER NEWS.** Sprague Products Co., N. Adams, Mass., 4 pp. First of series of bulletins to be issued.

**REPLACEMENT GUIDE TO PORTABLE BATTERIES.** Burgess Battery Co., Freeport, Ill. 4 pp. What types of batteries to use in various makes of portables.

**CRYSTAL BULLETIN E-7.** Bilely Elec. Co., Erie, Pa. Valuable data on use of quartz xtals. (Free from mfr. or distrib.)

**ESSENTIAL CHARACTERISTICS OF METAL & GLASS RADIO TUBES.** Ken-Rad Tube & Lamp Corp., Owensboro, Ky. 8 pp. Latest issue, revised to May 15.

**RADIO TIME BUYERS' BIRD'S EYE VIEW.** National Best. Co., N.Y.C. 4 pp. Survey of radio ownership in U.S.

## AN EDITORIAL

(Continued from page 165)

of time and labor, with materials as a secondary portion of the costs, it seems to me that the very small percentage in price between established brand parts and others should hardly prove much of a sales inducement. In these days, when more and more service jobs must be guaranteed for a certain period following the installation of replacement parts, the Serviceman can ill afford to take any chances. He needs all the insurance he can get.

So please bear in mind that little matter of insurance, if you are not a born gambler. The odds may be too much against you if you take chances.

## SURVEY OF NYC SHOWS SET MARKET

(Continued from page 163)

their existence, or a luxury they can afford! At least the readers of the *New York Herald-Tribune* indicate that, from a study of homes just completed. The survey was undertaken primarily to enable the great metropolitan daily to serve its readers better by knowing their needs and desires and the manner in which they live. But it is an interesting commentary also on the trend of the times—of vast significance to the radio trade generally.

A picture of the home life of a New Yorker of the middle class or better is a picture as drawn by the readers of the *Herald-*

*Tribune* that includes a radio! In fact 33.1% of the paper's readers own 2 radios or more, and only 0.7% do not own one. The average age of the radios, the survey discloses, is 4.4 years, although 7.8% reported models of 1928 or earlier. Radios acquired in 1936 accounted for 15.6% of the total, while those bought in 1937 totaled 14.1%. Almost half the multiple-owned radios were bought 2 years apart or less, with 33.6% purchased 5 years apart or longer.

Yet, as popular as radios are in the home, they are not nearly so universally used in the family motor car. Every 100 *Herald-Tribune* families owns 76 automobiles, the home survey reveals, but of these only 28.5% are radio equipped.

But there is a potential market of no mean proportions for radio dealers, the newspaper's study would seem to indicate, for 22.2% of the paper's audience expects to buy new radios this year, 13.4% next year and another 13.1% in the near future. An additional 40.5% of radio owners are undecided on the possible date for the acquisition of a new model, but a new radio is in the offing just the same.

Experiment, it seems, is not all confined to the amateur, for only 33.5% of those who have radios expect to replace them with later models of the same make. Those who expect to change brands number 29.3%, while those who are undecided on preferences for the future account for 36.9%.

## SUCCESSFUL SERVICING

(Continued from page 153)

the standard rate of \$3 an hour, with parts billed at cost plus a handling charge of 10%. A check-up of jobs of this nature over a 3-months' period showed time per job as averaging 19-and-a-fraction minutes each.

Advertising of the concern, which is consistently maintained in the local newspaper at an average cost of \$25 per month, emphasizes that while no cut or bargain prices are offered, the customer is guaranteed honest treatment and full value for every dollar spent. The following example will illustrate:

### OUR PROFESSIONAL SERVICE FEE

*We value our time at a much higher rate than any other company we know of—but for value received we can honestly refer you to our many satisfied customers. Ask any or all of them. Three dollars is our fee, minimum or per hour. We invite you to investigate. Thank you.*

### COMMUNITY RADIO LABORATORY

Photographs of the shop, which, as the accompanying illustration shows, is made up of latest and most modern Clough-Brengle instruments for rapid dynamic testing and visual precision check and alignment, have been extensively employed in advertising, with resulting favorable press comment and increased volume of high-class trade, with midget receivers gratifyingly absent.

As is apparent from the illustration, work is performed at the front of the shop, where customers are privileged to look on all they like, and satisfy themselves that in work expertly performed with latest precision, time-saving instruments, they are actually getting most for their money.

"There is no better success formula for Servicemen," says Waldron, "than to know your business and let the public know you know it. Expert work plus good showmanship pay excellent dividends on time and money invested."



# RADIO TRADE DIGEST

## ARTHUR MOSS HEADS PARTS DISTRIB. ASSN.

(Continued from page 163)

A. To organize into an Association every parts distributor eligible for membership and to promote cooperation and harmonious dealings between them.

B. To present to all branches of the radio industry a voice which will speak for the parts jobbers as a national unit.

C. To represent the parts distributors in discussions with manufacturers of problems which face its members and by a careful study endeavor to find a solution satisfactory to both the jobbers and manufacturers.

D. To cooperate with the manufacturers in establishing and maintaining definite standards and qualifications necessary to be rated as a distributor.

E. To provide for the distributor a national office which will assist its members in many ways, amongst which a few subjects are evidently of primary importance such as:—

1. Proper cost accounting methods. It is the intention of the Association to make available to its members the results of surveys in the field showing by percentages average cost of doing business. To furnish forms to its members so that they can compare their expenses with other jobbers throughout the country.

2. The development of merchandising plans which will suggest new and additional markets.

3. To provide means for satisfactorily ironing out any internal dissensions.

4. To assist its members through local jobbing cooperation in the problem of credit so that credit losses may be cut down to a minimum throughout the industry.

5. To create through promotional and advertising campaigns to servicemen, dealers, and amateurs a feeling of ab-

solute confidence in the business ethics of the members of N.R.P.D.A.

### GENERAL

A Code of Ethics will be prepared to which all members are expected to adhere. In disputes between members, all facts will be submitted to a grievance committee for final arbitration. Any member who wilfully continues to violate the code of ethics after proper notice may lose his standing as a member in good standing in the Association.

### MEMBERSHIP

The present membership (following a very successful series of meetings during the recent June Trade Show held in Chicago) numbers about 125 and includes many of the most prominent companies in the country. A rough estimate would be to say that the membership at present represents about 50% of the buying power. This is a good start and we expect within a short period of time to include in our membership every parts distributor doing a business of \$25,000 or more annually of a strictly wholesale nature.

All jobbers, large or small, who will subscribe to the by-laws of the association may become members subject to approval by the membership committee. Only through the real cooperation of large and medium size distributors will important problems which affect all alike be solved. The N.R.P.D.A. will definitely be the voice of the entire jobbing industry and carry on all its activities in a manner fair and equitable for each and every member in the Association.

### CONCLUSION

It is the sincere aim that through the N.R.P.D.A. members will promote their best interest; get to know their competitors better; collectively solve their problems; be able to build their own business through cooperation and achieve the real objective in all business—"A Fair Profit."

## SERVICING QUESTIONS & ANSWERS

(Continued from page 153)

on the speaker on both receivers I merely unplugged the speaker from the Air Castle and plugged it in the Detrola. The volume output was normal and satisfactory.

(A.) Although the D.C. resistance of each section of an output transformer primary is of consequence, the major item is that of inductance. In the usual construction of push-pull output transformers, the primary is started at the core. Were each primary

section to contain an equal number of turns so that the D.C. resistance of each primary section were equal, then the inductance or impedance relation would be unbalanced, since one section is closer to the core than the second, and would possess greater inductance. For this reason, the primary section closer to the core contains less turns, and consequently, the D.C. resistance of each section is unequal.

## THE RADIO MONTH IN REVIEW

(Continued from page 135)

Newest aid to beauty is the radio mask featured on the cover of this issue of *Radio-Craft* and at upper-left on pg. 134. Frequently used in conjunction with infra-red rays, this soft-rubber facial mask claims as a source of efficacy, in its radio beauty treatments, the "warmth developed deeply in the muscles of the face, causing impurities to be broken up and carried into the bloodstream." In addition to its use in treating skin blemishes these high-frequency radio waves are also said to aid in applying hot oils and creams which ordinarily have a tendency to cool by contact with the skin.

The "iron"-screen projection tube shown by drawing on pg. 135 is English patent No. 501,816, granted to F. J. G. Van den

Bosch, on a cathode-ray tube for large-screen television. Colloidal-iron particles held in suspension in paraffin oil are opaque to the rays from high-intensity lamp L until electrostatic charges on screen S, set up by the electron stream from gun L, cause the iron particles to be aligned end-on and thus permit passage of light.

The diagram on pg. 135 sub-titled "Programs Detonate Gunpowder!" is a novel means of putting radio programs to work at the receiver! The pulsating D.C. output of the rectifiers may also charge a 50-mf. condenser which is intermittently discharged by vibrator V into step-up transformer T. Thus both A.C. and pulsating D.C. could

(Continued on page 192)

*Spectacular New*  
**P.A. SYSTEMS**  
**Allied NOW OFFERS 3 COMPLETE LINES!**

Now, the greatest P.A. values in ALLIED's history! ALLIED's new 1940 Catalog shows 14 new Sound systems, 6 to 65 watts, portable, mobile, and permanent. 3 complete new lines—"Economy," "Standard," and "De Luxe"—new styling, new performance, new features! New Universal 20-watt AC-DC system with built-in phono—for 110 volts, AC-DC, battery, or 32 volt use—new portable P.A. design, etc. Also new Knight microphones, latest recording equipment, discs, all types of P.A. accessories. Get the full details of ALLIED's new Time Payment Plan (lowest carrying charges, easiest terms).

**SEND COUPON FOR NEW 1940 CATALOG**

ALLIED Radio Corp.  
Dept. 2-AJ-0  
833 W. Jackson Blvd.  
Chicago, Illinois.



- Send full details on new Knight Sound Systems.
- Send your new FREE 1940 Radio Supply Catalog.

Name \_\_\_\_\_  
Address \_\_\_\_\_  
City \_\_\_\_\_ State \_\_\_\_\_

## BRUSH •

### BJ HEADPHONES

Communications type—lightweight, durable aluminum case—phones encased in molded rubber jackets—good earseal.



Write for your Brush catalog today

### THE BRUSH DEVELOPMENT CO.

3311 Perkins Ave.

Cleveland, Ohio

## RADIO plus TELEVISION

*pre-tested Training*

No matter where you are or what you do, National has a complete training plan for you—to fit your circumstances. National's plan is for those seeking immediate shop-training as well as for those who cannot give up present employment and income. Mail coupon.



### NATIONAL SCHOOLS

NATIONAL SCHOOLS, Dept. U-11C  
4080 So. Figueroa St., Los Angeles, Calif.  
Please send free Radio and Television Booklet

NAME \_\_\_\_\_ AGE \_\_\_\_\_  
ADDRESS \_\_\_\_\_  
CITY \_\_\_\_\_ STATE \_\_\_\_\_

Please Say That You Saw It in RADIO-CRAFT

# QUALITY—VALUE—GUARANTEE!

## WESTINGHOUSE POWER GENERATOR

Manufactured for U. S. Signal Corps

**A. C. ELECTRICAL POWER**

200 Watt. 100 V. A.C.

from a Windmill, from available Waterpower, from your Bicycle, Automobile, from your Motorcycle, from your Bicycle, Footpedals or Handcrank (for transmitting Radio Signals), operate mixers, Strong Floodlights, Advertising Signs; operate two generators in series to get 200 V. A.C.; obtain two phase and three phase A.C. etc., etc.

**There Are Over 25 Applications**

Some of which are:

A.C. Dynamo lighting from eight to ten 20 Watt 110 Volt lamps. Short Wave transmitter supplying 110 Volts A.C. for operating "Ham" transmitter. Motor Generator, Public Address Systems, Electric Sirens on motor boats, yachts, etc. Camp Lighting, Short Wave artificial "fever" apparatus, Television, Pelton Waterwheel for lighting or other purposes, Airplane: for lighting strong search lights or electric signs, Laboratory work, etc., etc. 1/4 to 1/2 H.P. needed to run generator.

Generator, as described, including 2 1/2 x 12 PRINT 22 x 28 in. and Four-Page 8 1/2 x 12 in. INSTRUCTION SHEETS **\$7.90**

Send \$2.00 deposit balance C.O.D. Shipping weight 18 lbs.

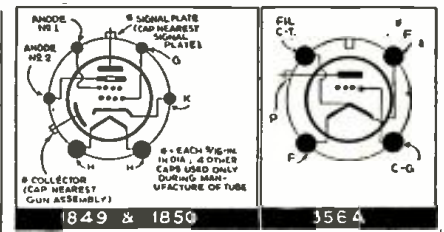
a 35Z5GT, which is a half-wave high-vacuum rectifier with tapped filament for pilot-light operation.

### 6SA7GT Pentagrid Converter

The type 6SA7GT is a single-ended pentagrid converter having a unipotential cathode with octal base; it is similar to the 6A7. Heater voltage A.C. or D.C. is 6.3 V., current is 0.3-ampere.

Complete characteristics are given in Table III.

### 12SA7GT Pentagrid Converter

The type 12SA7GT (similar to the 12A7) is also a single-ended tube similar in characteristics to the 6SA7GT, except that the heater voltage is 12.6 V. and the current is 0.15-ampere. Complete characteristics are given in Table III.

### 25D8GT Diode-Triode Pentode

Type 25D8GT is a heater-type diode-triode pentode designed for small A.C.-D.C. receivers where space is at a premium. The pentode section may be used as a conventional R.F. or I.F. amplifier and the diode-triode sections as detector and A.F. amplifier. A single plate of conventional design is provided around a cathode which is common to the triode! This tube is 3 9/16 ins. high, overall.

Tentative characteristics are given in Table IV.

## PYRO PANTAGRAPH

Size of box: 12 1/2" x 8 1/2"

**\$2.75**

SH. W. 3 LBS.

This electrical outfit is especially designed for burning designs permanently on Leather, Wood, Cork, Gourd, Bakelite, etc. Simply plug the Pyro-electric pencil in any 110-volt AC or DC outlet and it is ready to use. A special Pantagraph and cord furnished as part of equipment. By the use of a special Pantagraph included in the outfit any design may be reproduced either in original or enlarged form. Outfit consists of: one Pyro-electric Pencil, one Pantagraph, three hardwood plaques, one bottle of Varnish, one brush, one tracing tip and four page instruction sheet.

**\$2.75**

## G. E. PHONOGRAPH MOTOR

Formerly Sold for \$15.00

**\$4.95** ONLY

Variable speed induction type self-starting, 110 volt, 25 to 60 cycle A.C. with speed control plug and cord. Speed range from 5 to 200 R.P.M. Can be installed in place of old fashioned, hand-winding speed motor. Also ideal for display turn table, and a hundred other uses. These General Electric Motors have never been used and come four packed in original carton. G. E. Electric Phonograph motor as described (with-out turntable) **\$4.95**

Shipping Weight—12 lbs.



**ALL OUR MERCHANDISE IS UNUSED AND SOLD ON A MONEY-BACK GUARANTEE**

## MICROPHONE AND RECEIVER

This Microphone and telephone headset outfit was built especially for the U. S. Navy Aviation Corps the outfit to Government specifications.

The outfit consists of a low-impedance carbon metal breastplate, securely fastened to a low-impedance earphones. A specially constructed microphone circuit, the earphones are U.S.N. type, attached to adjustable headband. Twenty-eight feet of very heavy weather waterproof conductor cable is furnished. Current of not more than 10 volts should be used. A storage battery is the most satisfactory current supply.

U. S. Navy Airplane-type Microphone and Receiver as described **\$4.96**

Shipping Weight—9 lbs.

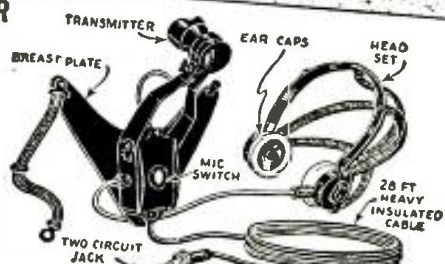

### NEW ICONOSCOPES

The Iconoscope as you are no doubt aware is a special form of (RCA) cathode-ray tube used in television transmission for "picking up" a scene and converting it into an equivalent electrical signal. The tube contains a mosaic plate on which the scene to be transmitted is focused by a lens, an electron gun which provides a cathode-ray beam for scanning the image on the mosaic, and a signal plate which acquires a voltage proportional to the image brightness of the particular spot being scanned at any instance. This voltage is the "video" signal for the television image. Two new types are described below. The overall length of these tubes is about 14 1/2 ins. The mosaic plate measures 4 1/4 x 3 1/2 ins., approx.

**WELLWORTH TRADING CO.**  
Dept. RC-939  
1915 SOUTH STATE ST., CHICAGO, ILLINOIS

\* ORDER DIRECTLY FROM THIS ADVERTISEMENT \*  
WE SHIP 24 HOURS AFTER RECEIPT OF YOUR ORDER, BY EXPRESS COLLECT OR PARCEL POST IF YOU INCLUDE SUFFICIENT POSTAGE.

## 9 NEW TUBES

(Continued from page 141)

dead-center on the tube. Since the ions are not affected by the electro-magnetic field of the yoke they continue at a tangent, completely missing the screen and thereby avoiding the darkening or spotting of same. No number has as yet been assigned to this new C.-R. tube.

### "PEANUT"-SIZE TUBES

#### XW 1.5-V. Midget Pentode

All midget vacuum tubes made by the (British) High Vacuum Valve Company (available in U. S. from most radio mail-order houses) are designed primarily for use in hearing aids. The latest addition to a growing line of these tiny, popular tubes—various types of which, in both 2-V. and

1.5-V. filament have been described in past issues of *Radio-Craft*—is a 1.5-V. R.F. pentode, characteristics of which are given in Table II. Among the other 1.5-V. tubes available from this company are the types XSG, a screen-grid tube; type XD, a triode; type XHP, a dual high-impedance triode and low-impedance triode; type XP, output triode; and type XY, an output pentode.

### NEW GLASS-BANTAM ("GT") TUBES

Arcturus brought forth 3 new bantam-type (small-space) tubes which include 2 single-ended pentagrid converters, and a special diode-triode pentode. In last month's (August) issue of *Radio-Craft* a 4th tube in this same series was announced, namely

### 1849 Iconoscope

RCA Iconoscope type 1849 is intended primarily for pick-up from motion-picture film. The tube therefore has been designed so that a sudden change in the average illumination on the mosaic does not cause the tube to generate a spurious signal.

For characteristics see Table V.

### 1850 Iconoscope

RCA Iconoscope 1850 is primarily designed for direct pick-up and has therefore been designed to have high sensitivity. As a result of this high sensitivity satisfactory operation of the 1850 can be obtained at most levels of scene illuminations. Each of these 2 Iconoscopes has a low value of output capacity which simplifies video amplifier design, and a window of polished glass

Please Say That You Saw It in RADIO-CRAFT



which minimizes optical distortion of the image.

Complete characteristics for this Iconoscope will be found in Table V.

**U.-S.W. TRANSMITTER TUBE**

**356A 50-W. 200-Megacycle Transmitter Tube**

A new ultra-highfrequency vacuum tube designed for operation in the range from 30 to 300 megacycles has just been introduced by Western Electric Company. This tube, the type 356A, utilizes the stemless type of construction pioneered in the W. E. type 316A tube (*Radio-Craft*, Jan. 1937). The reduced size of the tube thus made possible means a reduction in the lengths of the leads both inside and outside of the tube, an extremely important advantage in the operation of ultra-highfrequency circuits.

The 356A is a filamentary, air-cooled high-mu triode. As an R.F. oscillator it may be used at full rating at frequencies up to 100 megacycles and at reduced ratings up to 250 and even 300 megacycles. It is also suitable for use at audio frequencies, particularly in class B audio amplifiers or modulators where it may be used without grid bias at plate potentials as high as 1,000 V.

To avoid softening at the high operating temperatures the envelope is made of Nonex glass. The base is a 4-prong ceramic type. Overall length is 5 ins.; dia., 2 5/16 ins.

Characteristics of this tube are given in Table VI.

**CHARACTERISTICS**

(TABLE I—See top next column)

**XW—TABLE II**  
Ratings—R.F. Pentode

Filament voltage	1.5	volts
Filament current	66	ma.
Plate voltage	50	volts
Screen-grid voltage	45	volts
Control-grid voltage	4	volts
Plate current	0.75-	ma.
Screen-grid current	0.2-	ma.
Plate impedance	1	megohm
Mutual conductance	520	mmhos
Amplification factor	520	

**6SA7GT: 12SA7GT—TABLE III**  
Ratings (Tentative)

Heater:	6SA7GT	12SA7GT
Voltage (A.C. or D.C.)	6.3 volts	12.6 volts
Current (A.C. or D.C.)	0.3 ampere	0.15 ampere
Direct interelectrode capacities:		
Grid No. 3 to all other electrodes=R.F. input*	10.5	mmf.
Plate to all other electrodes=mixer output*	12.0	mmf.
Grid No. 1 to all other electrodes*	7.0	mmf.
Grid No. 3 to plate*	.13	max. mmf.
Grid No. 1 to No. 3 grid*	.15	max. mmf.
Grid No. 1 to plate*	.2	max. mmf.
Grid No. 1 to all other electrodes except cathode	4.4	mmf.
Grid No. 1 to cathode	4.0	mmf.

Typical operation:

**Converter Service**

	Self-Excitation		Separate Excitation	
	6.3	6.3	6.3	6.3
Heater voltage†	6.3	6.3	6.3	6.3
Plate voltage	100	250	100	250
Grids Nos. 2 & 4 voltage	100	100	100	100
Control-grid No. 3 voltage	0	0	2	-2
Grid No. 1 resistor	20,000	20,000	20,000	20,000
Plate resistance (approx.)	0.5	0.8	0.5	0.8
Conversion conductance	425	450	425	450
Grid No. 3 bias for conversion conductance=5 mmhos	-35	-35	-35	-35
Plate current	3.2	3.4	3.2	3.4
Grids Nos. 2 & 4 current	8	8	8	8
Grid No. 1 current	.5	.5	.5	.5

Note: The transconductance between Grid No. 1, and grids Nos. 2 and 4 tied to plate (not oscillating), is approx. 4,500 mmhos when grids Nos. 1 and 3 are at zero volts, and grids Nos. 2 and 4 and plate are at 100 volts.  
†Characteristics are approximate and are shown for a Hartley circuit with a feedback of approximately 2 volts peak in the cathode circuit.  
‡The potential difference between heater and cathode should be kept as low as possible.  
\*With base shield tied to cathode.

**117Z6G—TABLE I**

Ratings (Tentative)			
Heater voltage	58.5	117	volts
Heater current	0.150	0.075	ampere
Maximum D.C. heater-to-cathode voltage	350	350	volts
Maximum peak inverse voltage	700	700	volts
Tube voltage drop at 120 ma. per plate	15.5	15.5	volts

**Operating Conditions and Characteristics**  
**Voltage Doubler**

Heater voltage	117	volts
A.C. voltage (per plate), (r.m.s.)	117	volts, max.
D.C. output current	60	ma., max.
Peak plate current	350	ma., max.
Plate supply impedance (per plate), (min.)*		

**Half-Wave Rectifier**

Heater voltage	117	117	117	volts
A.C. voltage (per plate), (r.m.s.)	117	150	235	max. volts
D.C. output current (per plate)	60	60	60	ma., max.
Plate supply impedance (per plate), (min.)*	0	40	100	ohms, min.

\*Sufficient impedance to limit maximum peak plate current to value shown.  
Note: Ratings marked maximum are design centers for a line voltage of 117 volts.

**25D8GT—TABLE IV**

Ratings (Tentative)		
Heater voltage	25.0	volts
Heater current	0.15	ampere
Pentode Section		
Plate voltage	100	volts
Screen-grid voltage	100	volts
Control-grid voltage	-3	volts
Plate current	8.5	ma.
Screen-grid current	2.7	ma.
Plate resistance (approx.)	200,000	ohms
Transconductance	1,900	mmhos
Control-grid voltage for trans-conductance=2 mmhos (approx.)	-35	volts

**Triode Section**

Plate voltage	100	volts
Grid voltage	-1	volt
Plate current	0.5	ma.
Plate resistance	91,000	ohms
Transconductance	1,100	mmhos
Amplification factor	100	

**Diode (see text)**

Direct Interelectrode Capacities		
Pentode G <sub>1</sub> to plate	.015	mmf. (max.)
Pentode input	5.2	mmf.
Pentode output	10.0	mmf.
Triode grid to plate	2.5	mmf.
Triode grid to cathode	3.7	mmf.
Triode plate to cathode	4.5	mmf.
Pentode G <sub>1</sub> to triode grid	.01	mmf. (max.)
Pentode plate to triode grid	.10	mmf. (max.)
Pentode G <sub>1</sub> to triode plate	.02	mmf. (max.)

**1849: 1850—TABLE V**

Tentative Characteristics and Ratings			
Heater voltage (A.C. or D.C.)	6.3	volts	
Heater current	0.6	ampere	
Direct interelectrode capacities:			
Signal plate to collector (with external shielding)	10	approx. mmf.	
Base		medium 6-pin, ceramic	

(Continued on following page)

*Laugh at obsolescence*  
WITH  
**RCP TUBE TESTERS**  
*—it's easy and economical*

You've got to be able to test all the new tubes to be up-to-date. But take it easy. Modernize the economical way with RCP tube testers. Check the features—then check RCP prices. You'll find RCP the reliable and thrifty way to beat obsolescence.

**HIGH in Reliability**  
**low in cost**  
RCP Model 308  
**NEW DYNOPTIMUM TESTER**



Now's this for performance! Tests up to 225 volt tubes all metal MG. glass, O2A, cold cathode rectifiers, octal, local, single end tubes and all ballast tubes. Test all pilot lights, etc. Tests made at R.M.A. specified plate voltages and loads—finest co-reactive test. Not interelement shorts and leakage test between ALL INDIVIDUAL ELEMENTS. Audible test of noisy tubes. Counter-type tube checker. Easier to operate than any other approved tube checkers. **\$16.95** yet costs only **\$18.95**  
Portable Model 308P . . . **\$18.95**

Additional features of this tester and other RCP instruments free on request.  
**SEE YOUR JOBBER OR WRITE FOR CATALOG**

**RADIO CITY**  
PRODUCTS CO. INC.  
88 PARK PLACE, N. Y. C.

**Learn RADIO**  
with *Ghirardi's Home-Training Course*  
**COMPLETE IN 1 BIG BOOK**

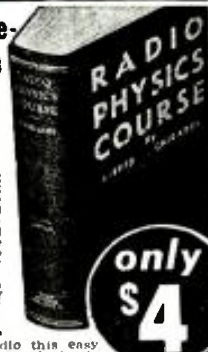

Here is your BIG CHANCE to get into RADIO! This ONE handy volume gives you the complete basic theory and fundamentals of Radio, Electricity, Television, Sound and Cathode-Ray Tubes—the same course used by more radio schools and students than any other radio book in the world. Think of it!—for \$4 you too can thoroughly equip yourself for a lifetime radio career!

**EASY AS A. B. C.**  
It's a pleasure to learn radio this easy way! Everything is made clear and simple—practical short-cuts speed your training. No math—no previous training necessary!

**36 VOLUMES IN 1 — 972 PP. — 508 ILLUS.**  
1. Radio Broadcasting System. 2. Sound, Speech, Music. 3. Electron Theory; Elec. Current. 4. Elec. Units; Ohm's Law; Resistance. 5. Elec. Circuits; Batteries. 6. Magnetism. 7. Electro-magnetism. 8. Electromagnetic Induction. 9. Inductance. 10. Capacitance; Condensers. 11. A.C. Circuits. 12. Filters. 13. Measuring Instruments. 14. Radio Waves. 15. Broadcasting. 16. Receiving. 17. Vacuum Tube Principles. 18. Vacuum Tube Characteristics. 19. Vacuum Tube Construction. 20. Vacuum Tube Detector and Amplifier Action. 21. Radio Frequency Amplification. 22. "Superhets." 23. R.F. Amplifiers; Tuning Coils. 24. Audio Amplifiers. 25. Speakers. 26. Battery Operated Receivers. 27. Power-Supply Units. 28. Elec. Receivers. 29. Automobile and Aircraft Radio. 30. Photo Pickups; Sound Systems. 31. Short-Wave. 32. Photoelectric Cells; Cathode-Ray Tubes. 33. Television. 34. Antennas and Grounds. 35. Testing; Servicing. 36. Sound . . . 356 Self-Review Questions!

**USE IT 5 DAYS — OUR RISK!**  
Yes, if you can part with the book after 5 days, return it and get your money back. No risk—no trouble—just clip the coupon—and mail it NOW!

**MAIL COUPON TODAY!**  
Radio & Technical Publishing Co.  
45 Astor Place, New York, Dept. RC-99  
 Here is my \$4. Please send RADIO PHYSICS COURSE postpaid, with money-back guarantee.  
NAME \_\_\_\_\_  
ADDRESS \_\_\_\_\_  
CITY \_\_\_\_\_ STATE \_\_\_\_\_  
 Send free descriptive literature.

Please Say That You Saw It in RADIO-CRAFT

# RSA Membership is as Necessary to You as Your Test Equipment

RSA is the only organization of Servicemen that has the sponsorship of the Radio Manufacturers' Association and the Sales Managers' Clubs, as well as the endorsement of the entire industry.

RSA has sponsored over 200 service meetings the past year in co-operation with manufacturers and engineers.

RSA has members in every state in the Union—and in most foreign countries.

RSA provides service diagrams, advanced circuit notes for members each month, technical help on service problems, access to its National Speakers' Bureau, advanced service courses to members at slight cost, a

monthly RSA publication, and many other benefits.

RSA is constantly developing New Ideas—New Services—and expanding old services.

RSA will soon announce a plan to help members get more business.

Help yourself by joining RSA—Do It Now!

*Let's Grow Together in 1939!*

**MAIL THIS COUPON NOW!**

RADIO SERVICEMEN OF AMERICA, INC.  
304 S. Dearborn St., Chicago, Ill.

Name .....

Address .....

City ..... State .....

I am interested in RSA Membership Tell me about it. ....

I am enclosing \$4.00 for National dues and initiation. ....

(Does not include Local Chapter dues where Local Chapters are organized.)

RC-939



**RADIO SERVICEMEN OF AMERICA, INC.**

Joe Marty, Jr., Executive Secretary  
304 S. Dearborn Street, Chicago, U.S.A.

## 9 NEW TUBES

(Continued from preceding page)

Maximum Ratings and Typical Operating Conditions	
High voltage electrode (anode No. 2) voltage	1,200 max. volts
Collector voltage	1,200 max. volts
Focusing electrode (anode No. 1) voltage	450 max. volts
Control electrode (grid) voltage	never positive
Grid voltage for current cut-off	-30 approx. volts
Collector current*	0.25 max. microamp.
Ambient temperature	40 max. °C
Typical operation:	
Heater voltage	6.3 volts
Anode No. 2 voltage	1,000 volts
Collector voltage	1,000 volts
Anode No. 1 voltage	360 volts
Grid voltage	-25 approx. volts
Collector current	0.05 to 0.1 approx. microamp.

Max. direct plate current	120 ma.	for use with	
Max. plate dissipation	50 watts	100% modulation	
Max. R-F grid current	6 amperes		25 25 20 15 watts
Max. direct grid current	35 ma.		
Max. frequency for above ratings	100 megacycles		
Max. plate voltage for upper frequency limit of 250 mc.	1,000 volts		
Class B Radio-Frequency Amplifier			
Direct plate voltage	1,500 1,250 1,000 750 volts		
Grid bias	-17 -8 0 0 volts		
Direct plate current for carrier conditions	50 60 60 60 ma.		
Approximate carrier watts			

Ultra-High-Frequency Operation  
For frequencies above 100 megacycles, the maximum plate voltage must be reduced as follows:

Frequency	100	150	200	250 mc.
Plate voltage: Class B or Class C Unmodulated	1,500	1,400	1,250	1,000 volts
Class C Plate Modulated	1,250	1,175	1,050	800 volts

The plate dissipation should not be allowed to exceed 50 watts.

## MORE ON NEUTRALIZED FEEDBACK

(See article on page 154 and 155)

\*When collector-current measurements are made, the nosele should not be illuminated. Allowance should be made for leakage currents.

356A—TABLE VI

Ratings	
Filament voltage	5.0 volts, A.C. or D.C.
Nominal filament current	5.0 amperes
Average thermionic emission	1.0 ampere
Average characteristics with a plate current of 100 ma.:	
Amplification factor	50
Grid-to-plate transconductance	3,800 mmhos
Plate resistance	13,000 ohms
Average direct interelectrode capacities:	
Plate-to-grid	2.75 mmf.
Plate-to-filament	1.0 mmf.
Grid-to-filament	2.25 mmf.
Maximum ratings:	
Max. direct plate voltage	1,500 volts

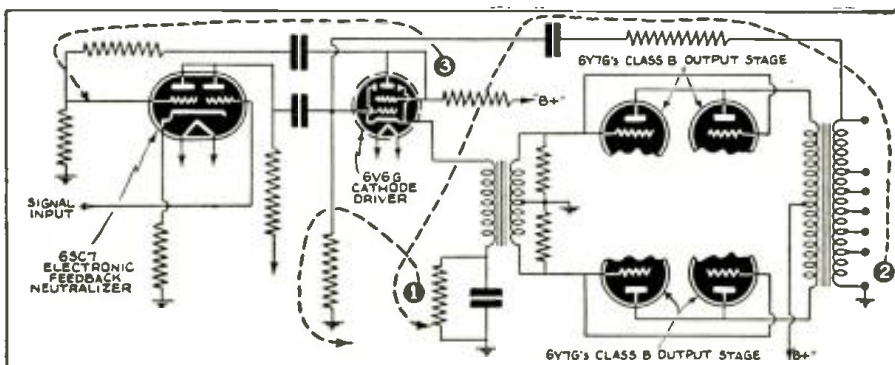

Basic circuit of neutralized feedback amplifier. This more detailed illustration of the block diagram on the cover of this issue of *Radio-Craft* shows that gain is controlled in the following manner: (1) cathode circuit negative feedback (degeneration), -6 db.; (2) 2-stage looped feedback (degeneration), -4 db.; (3) interstage positive feedback (regeneration), +10 db. Total loss of gain is 0 db.

Please Say That You Saw It in RADIO-CRAFT



**1st PRIZE MANUSCRIPT**

*(Continued from page 140)*

**DESCRIPTION OF A PUBLIC ADDRESS INSTALLATION FOR A CLUB AND BAR LOCATED IN MIAMI, FLORIDA**

It is a rule of our company to thoroughly read the daily newspapers for leads. The Real Estate section giving the building permits gave us first notice of this proposed club, and contact with the builder was established.

Miami has a reputation of being overcrowded in all businesses, and P.A. work is no exception, so we soon found competitors on the job. Six companies actively bid for the work but we got the job by the simple-but-unheard-of "trick" of selling him two amplifiers instead of one. (A spare with instantaneous change-over.) He had already contracted for entertainers such as Dwight Fiske, Irene Bordoni, Sheila Barrett, etc., and so could not tolerate a breakdown as these people get upwards of \$1,000.00 per week.

After checking building plans and owner's operating plans we arrived at the following equipment and prices:

2—25-watt amplifiers with 2-channel inputs, @ \$47.50	\$ 95.00
2—sets of tubes, @ \$12.50	25.00
6—10" P.M. speakers with variable line trans.	73.50
2—12" P.M. speakers with variable line trans., @ \$24.50	49.00
1—Hand crystal-microphone for use at bar	32.50
1—Stand velocity-microphone for orchestra and entertainers	75.00
1—Steel wall-cabinet, panels, panel lighting, brackets	30.00
Cable, outlet plates, connectors, wiring materials	20.00
Misc., including remote control and engraved plates	10.00
Engineering service	400.00
Labor—assembly of rack and all installation	100.00
	<b>\$910.00</b>

Deduct a normal discount of 40% on materials and 25% on labor, and add engineering fee, to arrive at net profit of \$589.00.

(Conduit was installed by electricians under electrical contract.)

The sale of equipment alone and installation without extra charge is not good business. An itemized list of equipment is never shown to the prospect (that is, with price of each unit) as he would accuse us of profiteering, but rather, a net price and the materials we agree to furnish. Our rather large profit is justified by: uninterrupted service; carefully planned, flexible installation; and, the compliments that the owner receives from his entertainers and the public.

The building is divided into 2 parts: a cocktail lounge and a dining room. During cocktail time entertainment is had either from the small stage having a Hammond organ and soloist microphone or from guests around the bar which has its microphone which may be connected to any of 5 outlets. Occasionally music from this room is relayed to the dining-room speakers. The dining-room stage located above a small dance floor has its microphone for orchestra or floor-show use. Music from this room may also be relayed to the cocktail room. Since entertainment is never carried on in both rooms at the same time these stage microphones are on the same channel (both outlets in parallel).

In the dining-room it was necessary both for appearance and even sound coverage to locate the speakers in the ceiling. The 6 speakers are arranged in groups of 2 for switching. In the cocktail lounge two 12-inch speakers capable of greater output are installed in the wall and are quite concealed by the murals. As it was necessary to locate the amplifier cabinet in the kitchen; a remote control box with low-capacity leads to the amplifier houses the volume controls and a pilot. In case that one amplifier breaks down, instant switching of inputs, volume controls, output and A.C. line is accomplished by a single lever, and the faulty amplifier can be repaired at leisure.

**THE LATEST RADIO EQUIPMENT**

*(Continued from page 182)*



**A VIBRATOR AND SUBSTITUTE SPEAKER TESTER (1782)**

(The Hickok Electrical Instrument Co.)

THIS unit, according to the manufacturer, is the "missing link" in radio equipment for testing auto sets and vibrators. The meter contained in the instrument is connected to the speaker winding on the output transformer so that it indicates outputs in watts. The vibrator testing circuit tests under actual operating conditions with the vibrator in the set. Its substitute speaker section includes a permanent-magnet speaker with universal output transformer for

matching a load of 2,000 ohms to 30,000 ohms in 7 steps. It is claimed that any receiver output can be properly matched. The substitute speaker field resistance may be varied from 300 ohms to 10,000 ohms, making it unnecessary to remove speaker from cabinet for servicing either home or auto radio sets. The instrument is known as TS-50.

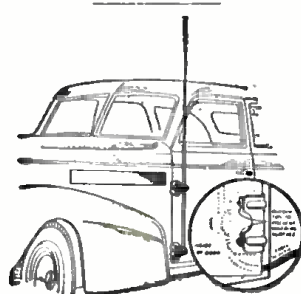

**NEW AUTO ANTENNA (1781)**

(Insuline Corp. of America)

AN outstanding feature of this new auto antenna is the fact that it requires no drilling of holes to mount and it fits all cars. They mount on the cowl by tightening 4

**Do You Realize**

that an increase of 3 D.B. in the efficiency of a speaker amounts to exactly the same thing as doubling the power output of your amplifier?

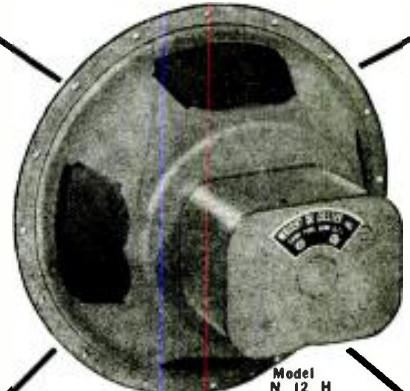

The N12H NOKOIL 12" Speaker handles 20 watts and gives greater power output at minimum cost.

Ask Your Jobber for a demonstration

**WRIGHT-DECOSTER, Inc.**

2251 UNIVERSITY AVE., ST. PAUL, MINN.

Export Dept.: M. Simons & Son Co., New York  
Cable Address: "Simonrice"

Canadian Representatives:  
Wm. F. Kelly Co., 1207 Bay St., Toronto, Ontario  
Taylor & Pearson, Ltd., Edmonton, Alberta



**So you can build with CONFIDENCE**

● This tiny electrolytic costs only 50 cents list. But it could cost many dollars if it broke down and endangered tubes and associated components. That's why the AEROVOX guarantee, backing ALL our products (packed with each condenser) is so essential to you. ● Ask your jobber about it—and ask for latest catalog. Or write us direct.



Please Say That You Saw It in RADIO-CRAFT



# FOUR NEW 10¢ RADIO BOOKS!



**RADIO FANS EVERYWHERE**—these little ten cent text books give you an excellent foundation for the study of radio. They are clearly written, profusely illustrated and contain over 15,000 words in each book. You'll be amazed at the wealth of information these volumes have. They are handy for review or reference books.

**NO. 5—BEGINNERS' RADIO DICTIONARY**  
Are you puzzled by radio language? Can you define frequency? Kilocycle? Tetrode? Screen grid? Baffle? If you cannot define these very common radio words and dozens of other, more technical, terms used in all radio magazines and instruction books, you need this book in your library. It's as modern as tomorrow—right up to the minute. It tells you in simple language just what the words that puzzle you really mean. You cannot fully understand the articles you read unless you know what radio terms mean. This is the book that explains the meanings to you. Can you afford to be without it, even one day longer?

**NO. 6—HOW TO HAVE FUN WITH RADIO**  
Stunts for parties, practical jokes, scientific experiments and other amusements which can be done with your radio set are explained in this fascinating volume. It tells how to make a newspaper talk—how to produce silent music for dances—how to make visible music—how to make a "silent radio" unit, usable by the deafened—how to make toys which dance to radio music—fifteen clever and amusing stunts in all. Any of these can be done by the novice, and most of them require no more equipment than can be found in the average home. Endless hours of added entertainment will be yours if you follow the instructions given in this lavishly illustrated book.

**NO. 7—HOW TO READ RADIO DIAGRAMS**  
All of the symbols commonly used in radio diagrams are presented in this book, together with pictures of the apparatus they represent and explanations giving an easy method to memorize them. This book, by Robert Eichberg, the well-known radio writer and member of the editorial staff of RADIO-CRAFT magazine, also contains two dozen picture wiring diagrams and two dozen schematic diagrams of simple radio sets that you can build. Every diagram is completely explained in language which is easily understood by the radio beginner. How advanced radio men will be interested in learning the derivation of diagrams, and the many other interesting facts which this book contains.

**NO. 8—RADIO FOR BEGINNERS**  
Hugo Gernsback, the internationally famous radio pioneer, author and editor, whose famous magazines, RADIO AND TELEVISION and RADIO-CRAFT are read by millions, scores another triumph with this new book. Any beginner who reads it will get a thorough ground work in radio theory, clearly explained in simple language, and through the use of many illustrations. Analogies are used to make the mysteries of radio as clear as "2+2 is 4". It also contains diagrams and instructions for building simple radio sets, suitable for the novice. If you want to know how transmitters and receivers work, how radio waves traverse space, and other interesting facts about this modern means of communication, this is the book for you!

**Other Titles in This 10c Book Series!**

- No. 1—HOW TO BUILD 4 DIERLE SHORT-WAVE SETS
- No. 2—HOW TO MAKE THE MOST POPULAR ALL-WAVE 1- AND 2-TUBE RECEIVERS.
- No. 3—ALTERNATING CURRENT FOR BEGINNERS
- No. 4—ALL ABOUT AERIALS

Four other volumes in this ten-cent radio book series—each on a popular subject—are available. The titles are:

RADIO PUBLICATIONS, Dept. RC-939  
101 HUDSON STREET, NEW YORK, N. Y.  
Gentlemen: Please send immediately, POSTPAID, the book numbers circled below. I am enclosing ..... cents—each book being 10c.

Send FREE listing of 48 new 10c Publications.

1      2      3      4      5      6      7      8

Name .....

Address .....

City ..... State .....

Remit by check or money order—register letter if you send cash or unused U. S. postage stamps.

**MAIL COUPON TODAY!**

**BOOKS ARE ALL UNIFORM**

Every book in the GERNSBACK EDUCATIONAL LIBRARY has 32 pages—with illustrations varying from 30 to 68 in number. Each title volume contains over 15,000 words. Positively radio's greatest book buy! If you do not think these books worth the price asked, return them in 24 hours and your money will be instantly refunded.

## RADIO PUBLICATIONS

101 Hudson Street New York, N. Y.

cushion bolts. A screwdriver is the only tool required for installation. A specially-designed spring makes positive contact and prevents rattling of the antenna when telescoped. Its insulators are made of bakelite.



Radio Lamp (1783)

### RADIO LAMP (1783)

(Radio Lamp Company of America)

ALTHOUGH *Radio-Craft* has in the past run constructional articles on how to make a combined radio and lamp, this is the first time, to our knowledge, that it has

been done commercially in as small and compact a unit as that illustrated in this department. The receivers used are superhets. of standard design, fitted compactly into the pedestal of the lamp, while the speaker is placed under the reflector pole in a special baffle plate, entirely covered by the lamp shade. The set covers the broadcast band

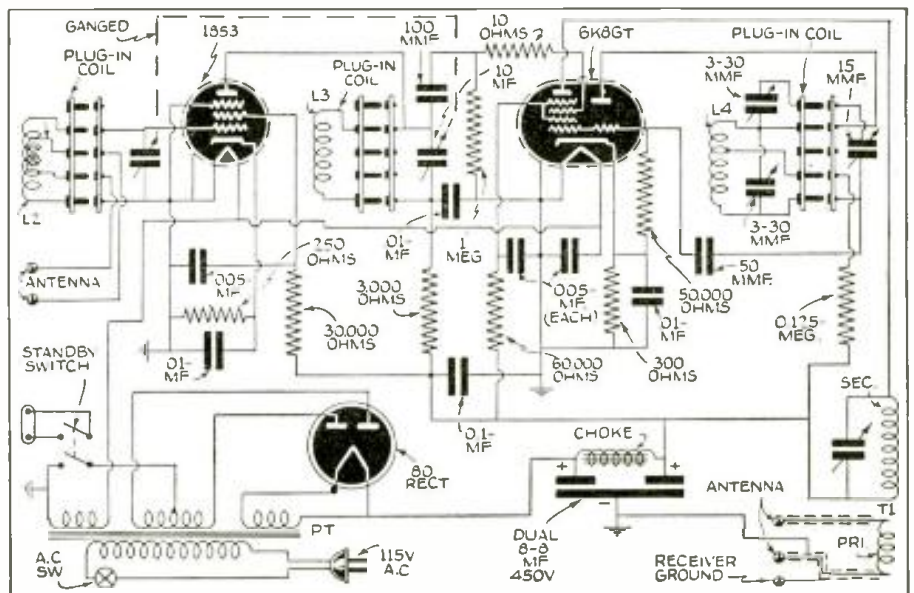

Diagram of ultra-high-frequency converter (Item No. 1773) illustrated on page 162.

Please Say That You Saw It in RADIO-CRAFT



from 1,750 to 540 kc.—an extended range which enables it to receive police calls and amateur stations. The line cord operates both radio and lamp. All sets are designed to operate from 110-120 V. A.C. or D.C. Various designs are available to blend with the furnishings of practically every type of home.



**NEW LINE OF RECORDERS (1784)**

(David Bogen Company, Inc.)

THE 16-in. model recorder illustrated in this department is an example of a complete line of recorders recently introduced by this company. Among its features are: 12-in. recessed turntable with 33 1/3 or 78 r.p.m. dual-speed motor; overhead lead-screw assembly and cutting head carriage; dual-action, lever-control cutting head; com-

pletely-insulated "floating power" internal rim drive; positive idler engagement and release; indicator for depth of cut. The particular unit shown is known as the model 212-RP recorder.



**CONDENSERS FOR HIGH-GAIN AMPLIFIERS (1780)**

(Sprague Products Co.)

THESE inverted screw-type can condensers have been designed especially for use in high-gain amplifiers, such as employed in television receivers, transmitters, exacting P.A. applications, etc. These new units are both oil-impregnated and oil-filled. The condensers are known as type PC and are available in 4 ranges: 2 mf., 600 V.; 4 mf., 600 V.; 1 mf., 1,000 V.; and 2 mf., 1,000 V.—all values being working voltages.

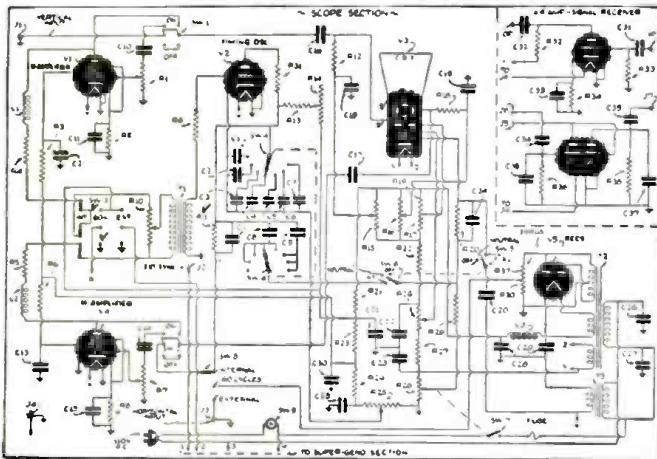

**CORRECTION DIAGRAMS**

Corrections to the diagrams in December 1938 and January 1939 issues of *Radio-Craft*, in the article, "Making a Serviceman's Test Unit—The 'Super-Geno-Scope'" are checkmarked (✓) on the redrawn diagrams at the left. Corrections of component values are indicated on the diagrams by an asterisk (\*). If super-regeneration is present in the Super-Geno section in R.F. oscillators V3, V4, due to changes in parts layout or other discrepancies, change R7-R27 to 0.1-meg. Presence of the super-regeneration will be noticed on the scope screen in the form of a composite or superimposed frequency upon the resonance image.

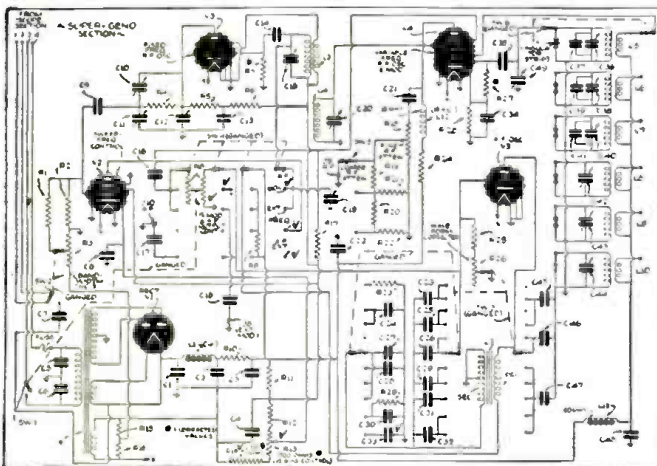

**Feature Articles in September RADIO & TELEVISION**

Looking Ahead in Radio, with J. R. Poppele, Chief Engineer, Station WOR.  
2 1/2 Meter Transceiver—Edward McQuade, WIEOG.  
How to Get Bigger and Better Television Images—Robert Eichberg.

A 3-tube S-W Converter-Superhet—Raymond P. Adams.  
Loktal 1-Tube Pre-Selector—Harry D. Hooton, WBKPK.  
The Radio Beginner—Martin Clifford.  
Best S-W Station List.

Please Say That You Saw It in RADIO-CRAFT

**Save Money!**  
With the  
**RADOLEK RADIO PROFIT GUIDE!**



**164 PAGES**

**OVER 15,000 REPAIR PARTS**

The world's most complete stock of radio repair parts and exact duplicate replacements. All leading brands. All guaranteed. Lowest Prices!

**COMPLETE TUBE SELECTION**

All types, RCA, Sylvania, Raytheon, Philco, etc. Includes Kellogg, special Majestic types and transmitting tubes. Complete selection.

**NEWEST TEST INSTRUMENTS**

The most complete line ever displayed in any catalog. All leading makes. Latest improved models at lowest prices.

**GREATEST RADIO VALUES**

A huge selection of super values as low as \$5.20. New Phono-Radio combinations. Automatic tuning sets. Beautiful cabinets. New "Itam" receivers and equipment.

**EVERYTHING FOR AUTO RADIO**

Complete auto radio section. Includes vibrator replacement guide, new auto aerials, custom panel control plates for all autos, newest Auto Sets.

**COMPLETE P. A. SELECTION**

New 1940 public address amplifiers from 10 to 100 watts. Complete P. A. Systems for permanent, mobile and portable installations. Best values!

**NEW ELECTRICAL APPLIANCES**

Extra profits for you! Standard Brand Electric Irons, Stoves, Heaters, Perculators, Waffle Irons, Vacuum Cleaners, Trains, Clocks, Mixers, etc., at lowest prices!

**FREE!**  
Mail Coupon Catalog

The **RADOLEK Co.**  
601 W. Randolph, Chicago,  
Dept. C-33

Send the 1940 Radolek Radio Profit Guide FREE.

Name .....

Address .....

Serviceman?  Dealer?  Experimenter?

# They Stay QUIET!

Three great engineering features make IRC Controls PERMANENTLY QUIET. DEPENDABLE. RUGGED. All three were pioneered and perfected by IRC. They are available ONLY in IRC Type CS Volume and Tone Controls. Each one involves more painstaking, more costly manufacture . . . yet you buy IRC Controls at ordinary control prices.

**FREE:** If you haven't already received your copy of the NEW IRC GUIDE (Edition No. 2) ask your jobber today. The finest, most complete GUIDE ever published. Includes the new IRC Wire Wound Controls, the new IRC Midget Controls and the new IRC universal shafts that save you time and money. Don't miss it!

### METALLIZED RESISTANCE ELEMENT

The ideal surface for amazingly quiet contact. You can actually feel the difference when you turn the knob.



### SILENT SPIRAL (POSITIVE) CONNECTOR

Metal-to-metal, sliding contact between rotor arm and end terminal is eliminated. Noise hasn't a chance.



### 5-FINGER "KNEE-ACTION" CONTACT

Each contactor acts independently. Each tracks smoothly and in perfect unison with a cushioned "knee action" effect.



**"Metallized" CONTROLS**  
INTERNATIONAL RESISTANCE CO  
401 N. Broad St., Phila., Pa.

## THE RADIO MONTH IN REVIEW

(Continued from page 185)

be made available for lighting lamps, detonating powder, etc., at a distance of about 12 miles from station Rome I (50 kw.).

*Paley-award* winner Burgess is shown on pg. 135, with June Gale Burgess; the YL is learning the radio code at the ripe young age of 10 months. On the wall (arrow) is a Worked All Continents certificate. K. B. Warner, A.R.R.L. secretary, was among the distinguished guests at the dinner which was tendered to him at the Hotel Pierre (New York) last month.

*Good television reception* is more than just a matter of pointing a telly camera at the subject to be televised, at some outside location or in the studios at Radio City (N.Y.), and transmitting the resulting image frequencies from the antenna of the Empire State Building. An essential step, for instance, is the following series of manipulations which take place in the television control room illustrated at lower-right on pg. 135.

A sound control engineer, video control engineer, program director, and camera supervisor, for instance, must make the switches from camera to camera. The high-fidelity audio (sound) portion of the television program is monitored by the technicians who are listening to the triangular-baffle loudspeaker, shown over the first of 3 monitor kinescopes, fitted into the corner between wall and ceiling. The kinescope monitors are used for checking the video (sight) portion of the program. The first or left-hand kinescope monitor screen shows the image that is on the air; the second or center one carries the preview that is being readied; and the third one, on the right, is used by the video control engineer in correcting image defects. All 3 video monitors are interchangeable.

### THEIR MAJESTIES

**P**RESIDENT and Mrs. Roosevelt planned to present their Britannic Majesties, King George VI and Queen Elizabeth, with an album of "radio transcriptions of the music which the royal pair heard at the White House following the state dinner," as a memento of the Washington visit, according to Pearson & Allens' N. Y. *Mirror* column "Washington Merry-Go-Round," last month.

When Their Majesties visited the New York World's Fair 1939, a group of 20 farmers from New Scotland and Altamont, in the hills near Schenectady, N. Y., 130 miles away, saw them better by television than did 99% of the hundreds of thousands of persons on the Fair grounds. A standard General Electric teleceiver, powered by a gas-driven generator, was used.

Station WMCA last month broadcast mobilization orders as a voluntary aid in calling to duty the members of the 71st Regiment of the N. Y. National Guard hurriedly called to service in assisting the royal entourage attending the King and Queen on their visit to President Roosevelt at Hyde Park.

The return of the royal party to England last month was the signal for a tremendous ovation by overflow audiences, in 3 Gaumont-British theatres in London, watching the reception ceremonies by large-screen (12x15 and 15x20 ft.) television.

## Index to advertisers

<b>A</b>	
Aerovox Corporation .....	189
Allied Radio Corporation .....	167, 185
Amplifier Co. of America .....	176
Amplitone Products Company .....	174
<b>B</b>	
Brush Development Company .....	185
Burstein-Applebee Company .....	174
<b>C</b>	
Central Radio Laboratories .....	172
Chung Yuen Electrical Co. ....	173
Classified Section .....	184
Cornell-Dubilier Elec. Corp. ....	175
Coyne Electrical School .....	170
<b>D</b>	
The Data Print Company .....	176
DX Radio Products Company .....	168
<b>F</b>	
Foto-Craft Magazine .....	178
<b>H</b>	
Hammarlund Mfg. Company .....	169
Hygrade-Sylvania Corporation .....	177
<b>I</b>	
International Resistance Co. ....	192
<b>L</b>	
Lafayette Radio Corporation .....	181
LANCASTER, Allwine & Rommel .....	174
Lincoln Engineering School .....	176
<b>M</b>	
Meissner Manufacturing Co. ....	Back Cover
Modell's .....	173
Modell's .....	176
<b>N</b>	
National Plans Institute .....	172
National Radio Institute .....	129
National Schools .....	185
New York Y.M.C.A. Schools .....	178
<b>O</b>	
D. W. Onan & Sons .....	174
<b>R</b>	
Radio & Tech. Publishing Co. ....	187
Radio & Television Magazine .....	178
Radio City Products Company .....	187
Radio Instruments Mfg. Co. ....	173
Radio Publications Mfg. Co. ....	190
Radio Servicemen of America .....	188
Radolek Company .....	191
RCA Institutes, Inc. ....	172
RCA Manufacturing Co. ....	131, 171
Readrite Meter Works .....	183
Remington Rand, Inc. ....	175
<b>S</b>	
The Rosierucian Order .....	171
E. H. Scott Radio Labs .....	168
Solar Mfg. Company .....	169
Sprague Products Company .....	179
Sprayberry Academy of Radio .....	183
Superior Instruments Co. ....	Inside Back Cover
Supreme Instruments Corp. ....	169
<b>T</b>	
Technifax .....	177
Triplet Elec. Instrument Co. ....	181
The Turner Company .....	174
<b>W</b>	
Wellworth Trading Company .....	186
Weston Elec. Instrument Corp. ....	179
Wholesale Radio Service Co. ....	181
Williams Philco, Inc. ....	174
Wright-DeCoster, Inc. ....	189

(While every precaution is taken to insure accuracy, we cannot guarantee against the possibility of an occasional change or omission in the preparation of this index.)



Superior Announces . . . .

FOR THE FIRST TIME — THE NEW

# CHANNEL-ANALYZER

Follows Signal from Antenna to Speaker of Any Set



### THE CHANNEL ANALYZER WILL—

1. Follow signal from antenna to speaker through all stages of any receiver ever made.
2. Instantly track down exact cause of intermittent operation.
3. Measure both Automatic-Volume-Control and Automatic-Frequency-Control, voltages and circuits without appreciably loading the circuit, using built-in highly sensitive Vacuum-Tube Voltmeter.
4. Check exact gain of every individual stage in receiver.
5. Track down and locate cause of distortion in R.F., I.F., and A.F. amplifiers.
6. Check exact operating voltage of each tube.
7. Locate leaky condensers and all high-resistance shorts, also show opens.
8. Measure exact frequencies, amount of drift and comparative output of oscillators in superhets.
9. Track down exact cause of noise.

FUNDAMENTALLY, what the Superior Channel-Analyzer does is to permit the serviceman to follow the *SIGNAL* from antenna to speaker through each and every stage of any set ever made, and inferentially, of any set that ever will be made, using the *SIGNAL* as the basis of measurements. Thus if there is trouble in one particular channel or stage of a receiver, the serviceman can isolate the faulty stage and then proceed to ascertain the very part or component that causes the trouble.

Many of the troubles in modern receivers are due to the Automatic-Volume-Control and Automatic-Frequency-Control circuits, and ordinary instruments do not permit measurements directly upon these circuits, so the Superior Channel-Analyzer includes a direct-current Vacuum-Tube Voltmeter that DOES make these measurements directly and with a negligible loading of the measured circuits.

Other problems cease to be problems too, when the quick-solution method of the Channel-Analyzer is applied. For instance, suppose a local oscillator in a superheterodyne drifts. The Channel-Analyzer has a switch operated, tuned input circuit with amplifier, whereby not only the presence of drift may be discovered, but also the amount and direction of drift.

Distortion is another difficulty that often nettles a serviceman. The Channel-Analyzer has a jack for the insertion of earphones so that you can listen to the signal directly from any stage and, therefore, discover the stage in which the distortion takes place. Next, the VTVM is used to discover the very component in that circuit that is causing the trouble.

How often have you cherished the hope that someday you would own an instrument that enables you to measure the actual signal voltage across the load of any stage in the set, and thus by comparison determine the gain per stage. The Channel-Analyzer enables those dynamic voltage measurements and does a whole assortment of other work besides, yet at a price much less than that usually asked for a dynamic voltmeter alone.

D.C. voltages have important bearings on receiver performance. All these voltages can be measured on the Channel-Analyzer with the receiver in reproducing operation. In fact, that one important consideration, MEASUREMENTS WITHOUT MOLESTATION OF THE RECEIVER, gets rid of the drawback of most conventional equipment which greatly reduces the very voltage it attempts to measure.

Tubes that are used in the receiver under test are also given a thorough check by the

Channel-Analyzer and as such a specialized tube tester, this new and remarkable instrument is proof against any possibility of obsolescence.

Noise, another serious problem to servicemen, can be located with the aid of the Channel-Analyzer and can be done with incredible speed. Here are the basic components of the Channel-Analyzer:

1. B Supply rectifier and filter circuit.
2. One-stage, high-gain flat amplifier and linear diode detector.
3. Tuned-circuit, high-gain amplifier and linear diode detector, 100 KC. to 20 MC.
4. D.C. Vacuum-Tube Voltmeter, for measuring the rectified R.F., I.F. or A.F., and for independent use on external circuits, all by front panel switching.

By adroit engineering and skillful application of a wide knowledge of servicing requirements based on Superior's years of experience, the four components listed above are made to do so many things and do them so well and fast that a large benefit is bestowed on servicemen, their tasks lightened, their work speeded and their experience greatly extended, all at record-breaking low price.

The Superior Channel-Analyzer comes housed in shielded cabinet and features an attractive, etched-aluminum panel. Supplied complete with tubes, three specially engineered shielded input cables, each identified as to its purpose. Also full operating instructions. Size 13" x 10" x 6". Shipping weight 19 pounds. Only . . . . .

**\$19<sup>75</sup>**

## THE NEW MODEL 1130-S SIGNAL GENERATOR WITH AUDIO FREQUENCIES



1. Combination R.F. and Audio Signal Generator. R.F. 100 kc. to 100 megacycles A.F.—100-7500 cycles. All direct readings, all by front panel switching.
  2. R.F. and A.F. output independently obtainable alone or with A.F. (any frequency) Modulating R.F.
  3. Accuracy is within 1% on I.F. and Broadcast bands; 2% on higher frequencies.
  4. Audio frequencies in 5 bands: 100, 400, 1000, 5000, and 7500 cycles.
  5. Giant airplane full vision, direct-reading dial.
  6. Condensers and other leakages tested to 100 megohms.
  7. All services on 90-130 volts A.C. or D.C. (any frequency).
- Model 1130-S comes complete with tubes, test leads, carrying handle and instructions. Shipping weight 16 lbs. Our net price . . . . . **\$11<sup>85</sup>**

## THE X-RAYOMETER FEATURES A NEW GIANT 9 INCH METER—AND A BUILT-IN POWER SUPPLY ENABLES RESISTANCE MEASUREMENTS UP TO 30 MEGOHMS



- SPECIFICATIONS**
- RESISTANCE MEASUREMENTS IN 3 RANGES: 0-1000 Ohms, 0-100,000 Ohms, 0-30 Megohms.
- D.C. VOLTAGE MEASUREMENTS IN 5 RANGES: 0-50, 0-250, 0-500, 0-1000, 0-2500 Volts. Television and other high voltage power supply circuits easily measured.
- A.C. VOLTAGE MEASUREMENTS IN 4 RANGES: 0-50, 0-250, 0-500, 0-1000 Volts.
- D.C. CURRENT MEASUREMENTS IN 6 RANGES: 0-1 Ma., 0-50 Ma., 0-250 Ma., 0-1 Ampere, 0-10 Amperes, 0-25 Amperes. High current ranges suitable for automotive and industrial work.
- CAPACITY DIRECTLY READ ON METER SCALE IN 2 RANGES: 005-1 Mfd., 0.0001-2 Mfd.-50 Mfd.
- PERCENTAGE OF LEAKAGE of electrolytics read DIRECTLY on meter scale. Actual condition of condenser quickly determined.
- INSULATION, INTER-ELEMENT and A.V.C. LEAKAGES directly read on meter scale up to 30 Megohms.
- OUTPUT MEASUREMENTS IN 4 RANGES: 0-750, 0-500, 0-1000 Volts. Built-in blocking condensers enable rapid alignment of radio equipment.
- INDUCTANCE MEASUREMENTS IN 2 RANGES: 0-7 Henries, 7-703 Henries.
- DECI-BEL MEASUREMENTS IN 3 RANGES: 10 dB. based on 6 M.W. at 500 Ohms, -10 to +20, -10 to +42, -10 to +49. Audio frequency measurements in both radio and P.A. amplifiers.

X-RAYOMETER comes housed in a new army gray crystalline, heavy gauge cabinet. Complete with test leads, instructions and tabular data. Shipping weight 20 pounds. **\$17<sup>95</sup>** ONLY

**SUPERIOR INSTRUMENTS CO.**

136 LIBERTY STREET, RC-9  
NEW YORK, N. Y.



# A New **TROUBLE SHOOTER**

## THE MEISSNER ANALYST

*In Kit form  
at about  
half the  
price*

*Note Ease of Reading  
Channel by Channel*

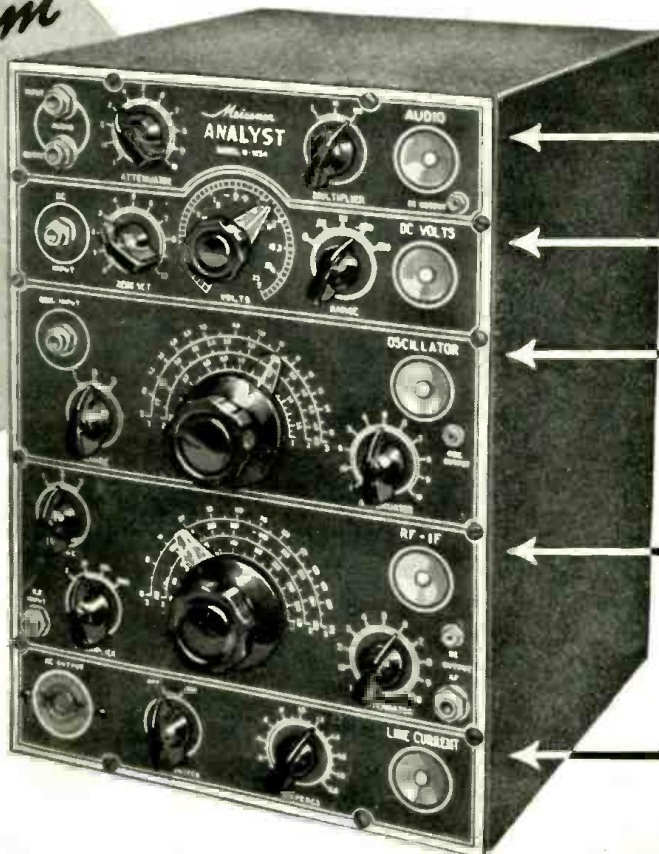

**AUDIO**  
50-50,000  
CYCLES

**VOLTMETER**  
5, 15, 50, 150,  
500 VOLTS

**OSCILLATOR**  
0.6 to 15.0 MC.

**RF-IF**  
95 to 1700 KC

**LINE CURRENT**  
0.3 to 3.0 AMP.

**SERVICES  
ANY TYPE OF  
RECEIVER  
\$60 NET**

The Meissner ANALYST is not only highly efficient—covering every conceivable phase of signal testing—but is surprisingly easy to read and operate. This up-to-the-minute instrument will work wonders in raising the standard of service in your shop. It will take the kinks out of your toughest servicing problems... step up your efficiency... save valuable time... increase your profits.

It accurately measures both control and operating voltages without affecting the operation of the set. Channels can be tested individually or simultaneously. Reading is greatly simplified. There's an individual panel for each channel.

And best of all you buy the ANALYST in KIT FORM... Save nearly HALF the cost of a factory-wired set of comparable quality and efficiency. And at the same time acquire a fundamental knowledge of this instrument and what it will do for you that could not otherwise be obtained by weeks of study and experiment.

Get the facts on this revolutionary TIME and TROUBLE SAVER... See the Meissner ANALYST at your Parts Jobber's—or mail coupon below for FREE FOLDER... It tells the whole story!

This Folder gives you complete facts on the Meissner ANALYST. Explains in detail the scores of testing operations it performs faster and better.



MAIL IN ENVELOPE OR PASTE ON PENNY POSTCARD

MEISSNER MANUFACTURING COMPANY  
Mt. Carmel, Illinois, Dept. RC-9

I want that folder on the Meissner ANALYST  
 Also your 1939-40 Catalog on the complete Line

Name.....  
Address.....  
City..... State.....



CABLE ADDRESS "MEISNRcoil"